

ABSTRACT

Title of Document: **CRIME IN COLLEGE PARK:
UNDERSTANDING CRIME LEVELS,
PERCEPTIONS, AND ENVIRONMENTAL
DESIGN IN AN OFF-CAMPUS STUDENT-
OCCUPIED NEIGHBORHOOD**

Camila Alvarado, Cal Burton, Vivey Chen,
Jessica Cutler, Luciana Debenedetti, Aleksandra
Derkacheva, Valentina Lopez, and Stephanie von
Numer

Directed By: **Dr. Charles Wellford, Department of
Criminology and Criminal Justice**

Despite recently decreasing crime rates in College Park, fear of crime remains high. Additionally, while the crime rate on the University of Maryland campus is relatively low compared to the national average, crime in off-campus areas continues to be a problem. Crime mapping using spatial analysis techniques allowed the researchers to identify Old Town College Park as a student-occupied, off-campus residential area with a relatively high rate of larcenies, burglaries and robberies. Through a longitudinal case study, quantitative and qualitative data about crimes and students' perceptions of crime in the target area were collected. These data were used to identify trends in how the rate of crime and perception of crime changed in response to the implementation of CCTV cameras in Old Town. These data were also used to identify the correlation between crime level and the existing environmental design of the neighborhood's housing properties.

CRIME IN COLLEGE PARK: UNDERSTANDING CRIME LEVELS,
PERCEPTIONS, AND ENVIRONMENTAL DESIGN IN AN OFF-CAMPUS
STUDENT-OCCUPIED NEIGHBORHOOD

By

Team Crime Prevention and Perception

Camila Alvarado, Cal Burton, Vivey Chen, Jessica Cutler, Luciana Debenedetti,
Aleksandra Derkacheva, Valentina Lopez, and Stephanie von Numers

Thesis submitted in partial fulfillment of the requirements of the Gemstone Program,
University of Maryland, 2011

Advisory Committee:
Professor Charles Wellford, PhD, University of Maryland, Chair
Lt. Steven Kowa, PhD, University of Maryland Police
Mr. John Firman
Dr. Joel Garner
Major Robert Liberati
Dr. Jean McGloin
Dr. David Soule

© Copyright by

Team Crime Prevention and Perception

Camila Alvarado
Cal Burton
Vivey Chen
Jessica Cutler
Luciana Debenedetti
Aleksandra Derkacheva
Valentina Lopez
Stephanie von Numers

2011

Acknowledgements

We would first like to thank our mentors, Dr. Charles Wellford and Lt. Steven Kowa, PhD, for providing immense support and guidance over the last three years. They taught us to think critically and pushed us to do our best work. Bob Ryan and the City of College Park offered major support to the team's research. The Prince George's County Police Department was indispensable in providing crime reports. Sean Goodison helped us greatly with the analyses of our data. We would like to thank Mr. John Firman, Dr. Joel Garner, Major Robert Liberati, Dr. Jean McGloin, and Dr. David Soule for serving as discussants at the thesis defense and providing us with expert feedback. This research would not have been possible without funding from the University of Maryland's Office of the Vice President for Administrative Affairs. Lastly, we thank the Gemstone staff for supporting us through every step of the research process.

Table of Contents

Acknowledgements.....	ii
Table of Contents.....	iii
List of Tables.....	iv
List of Figures.....	v
List of Appendices.....	vi
Chapter 1: Introduction.....	1
Background.....	1
Research Questions and Hypotheses.....	7
Chapter 2: Literature Review.....	9
Overview.....	9
Routine Activity Theory.....	10
Crime Prevention through Environmental Design (CPTED).....	16
Perception of Crime.....	21
CCTV as a CPTED Approach.....	24
Chapter 3: Methodologies and Methods.....	27
Methodology.....	27
Sample.....	27
Independent Variables.....	33
Dependent Variables.....	37
Chapter 4: Results.....	43
Crime Statistics.....	42
Survey.....	48
CPTED.....	57
Hypothesis 1.....	59
Hypothesis 2.....	63
Hypothesis 3.....	66
Chapter 5: Discussion.....	67
Summary.....	67
Implications.....	68
Limitations.....	73
Future Research.....	79
Appendices.....	81
References.....	161

List of Tables

Table 1: Characteristics of samples	29
Table 2: Comparison of samples with respective populations.....	32
Table 3: Camera sites inside the Old Town area of study.	35
Table 4: Crime statistics.....	44
Table 5: Likert scale questions	49
Table 6: Non-Likert scale questions	51
Table 7: The three groups of CPTED vulnerability.....	58
Table 8: Monthly crime counts and rates.....	60
Table 9: Average crime count and rate pre-intervention and post-intervention	61
Table 10: Tests of significance for crimes ($\alpha = 0.05$).....	62
Table 11: Tests of significance for survey responses	63

List of Figures

Figure 1: Routine activity theory	11
Figure 2: An illustration of CPTED's first generation's six principles	16
Figure 3: Research design.....	27
Figure 4: Crime hot spot in College Park	28
Figure 5: The Security Operations Center surveillance monitoring room.....	33
Figure 6: One of the surveillance cameras placed on the University of Maryland campus	34
Figure 7: The locations of security cameras in Old Town, College Park	35
Figure 8: Crimes by type (frequency).....	42
Figure 9: Crimes by type (percentage).....	43
Figure 10: Crimes by location.....	44
Figure 11: Distribution of CPTED vulnerability in Old Town, College Park	59
Figure 12: Monthly crime counts from January 2008 to February 2011	61
Figure 13: A crime-density map made in ArcGIS with crime data provided by the Prince George's County Police Department	149
Figure 14: An overhead view of the Old Town neighborhood in College Park	150
Figure 15: Property boundaries and building locations in the Old Town neighborhood of College Park as of 2006.....	151
Figure 16: A CPTED-adherence map of the Old Town neighborhood of College Park.	152

List of Appendices

Appendix A: CPTED Scale	81
Appendix B: Perception Survey for Residents of Old Town.....	83
Appendix C: Perception Survey for Non-Residents	94
Appendix D: Crime Coding Key	102
Appendix E: Extended Acknowledgements	103
Appendix F: The Diamondback Articles	109
Appendix G: Maps of College Park.....	149
Appendix H: Crime Prevention through Environmental Design (CPTED) Training	153
Appendix I: List of Acronyms	154
Appendix J: Technical Specifications for the Spectra IV IP Series Network Dome System.....	155

Chapter 1: Introduction

Background

Assessing the characteristics and contributing factors of crime necessitates a consideration of the characteristics of an area, specifically its physical and environmental aspects. Levels of crime may also be affected by the cohesiveness of a community, relationships between its citizens, and the stability of a population (“Crime Factors,” 1998). In a college community, off-campus student residential areas are of particular concern, as students must adapt their behaviors and security measures to the realities of the specific neighborhood or town in which they reside. There is also a large amount of turnover of residents from semester to semester and year to year, which affects the stability and consistency of the population, relationships among neighbors, and other factors that contribute to community cohesiveness. The University of Maryland, College Park, has a recurring discrepancy between crime rates on the university campus and those in off-campus student residential areas; while the crime rate on campus is relatively low, crime in off-campus areas continues to be a problem (*Local Explorer*, 2006). High levels of crime, in turn, may ultimately affect the perceptions and fear of residents and passersby of an area; the City of College Park has experienced a recent decrease in crime rates, but despite this decrease, fear of crime remains high (Goon, 2008).

At the University of Maryland, there exists a disparity between the crime rates on and off campus. Statistics from *The Washington Post* have revealed that the total crime risk for the 20742 zip code region—in which University of Maryland’s College Park campus is located—has a total crime risk that is 0.03 times the national average. Comparatively, the total crime risk in the surrounding off-campus areas with zip code 20740 is much higher, at 0.63 times the national

average. Statistics specific to property crime risk further indicate a much higher risk in off-campus versus on-campus areas. For instance, the risks of burglaries and larcenies in the 20742 zip code (on-campus) range from only 0.04 to 0.05 times the national average, whereas these property crime numbers are significantly higher in the 20740 zip code. In the 20740 zip code, burglary risk runs 0.25 times the national average and the risk of larceny is even higher at 0.81 times the national average. The statistics for robbery rates are also significantly higher for off-campus areas, at 0.70 times the national average, as compared to 0.02 times the national average in on-campus areas (*Local Explorer*, 2006). These statistics suggest that burglaries, larcenies, and robberies are of much greater concern to students residing off campus in the 20740 region (hereafter referred to as “residents” for the purpose of the study) than to those students who live, study, or work in the 20742 on-campus region (hereafter referred to as “non-residents” for the purpose of the study).

According to former Prince George’s County Police Chief Melvin C. High and former County Executive Jack B. Johnson, general crime rates in Prince George’s County have been decreasing in recent years (Rondeaux, 2007). Nevertheless, both Johnson and High maintained that property crime, which includes burglaries and larcenies, continues to be an on-going problem in the county. Thus, crime remains a key concern of residents and officials in College Park, Maryland.

This research and its findings address crime and crime reduction methods in student residential areas in the off-campus areas of College Park by evaluating the implementation of a

crime prevention strategy, Closed Circuit Television (CCTV)¹. This strategy is based on two related principles in criminology and criminal justice: Crime Prevention through Environmental Design (CPTED) and routine activity theory. In addition to evaluating the impact of CCTV, this research assesses both of these theories simultaneously because of the shared component—the role of environmental design in crime occurrences.

Crime Prevention through Environmental Design

An important aspect of the study concerns the level of CPTED in a community. The researchers utilized crime mapping and spatial analysis techniques to identify student-occupied residential areas off campus with the highest rates of larceny, burglary, and robbery. Through this mapping, Old Town College Park was identified as a hot spot for the types of crime specified above. Concurrent with the literature review and previous research on crime hot spots, CPTED is an integral part of determining the vulnerability of an area to crime, and how this activity can be either curtailed or prevented with the proper environmental design.

CPTED draws a relationship among the environmental factors in an area, the crime rate, and perceived feelings of safety—or, lack thereof. According to researchers Robert Stephens of the City of Toronto, Macarena Rau Vargas of the Chilean Urban Ministry, and Tinus Kruger of the South African Council for Scientific and Industrial Research, “at its most fundamental, CPTED deals with common-sense solutions to practical environmental problems” (Stephens, Rau Vargas, & Kruger, 2004, p. 1). CPTED principles are dynamic and applicable to a variety of environments—either within an existing infrastructure, or in the development of new areas—as well as a range of budgets. For example, simple measures such as trimming a bush that

¹ This research was supported by an award from the Office of the Vice President for Administrative Affairs (VPAA), University of Maryland. Without this support the study could not have been as successful as it has been. The VPAA is not responsible for any aspect of this research or its findings.

inhibits visibility or installing a fence in front of one's property are proven CPTED principles that may reduce crime (Ministry of Justice, 2005). CPTED is, therefore, an accessible means of crime prevention that allows both an individual and a community to implement its various principles in a specific environment.

The researchers worked in conjunction with the Prince George's County Police Department, in addition to relying on previously published CPTED site assessments to create its own assessment and CPTED evaluation scale for Old Town College Park. The researchers performed a series of assessments and evaluations on the area from the fall 2009 through fall 2010 semesters. These included visits at different times of night and day, and focused on assessing both the neighborhood as a whole (i.e. public property such as sidewalks and street lamps), as well as individual properties in the area using a CPTED scale developed by the researchers (see Appendix A).

Perception

In November 2008, the University of Maryland Police Department Spokesperson, Paul Dillon, said that in that year, both violent and property crime rates fell below the average of the last six years, but the public perception of safety had not necessarily increased (Goon, 2008). Supporting this disparity between actual crime rates and perceptions of crime, studies have also suggested that greater numbers of people fear crime at higher levels "than would seem to be warranted by actual crime rates, even if we assume a liberal amount of unreported crime" (Taylor & Hale, 1986, p. 152). This inconsistency between perceived and actual crime poses multiple problems for the students in College Park because it tarnishes the university's reputation while also creating a less inviting living environment. A poll conducted by the College Board (2008), which surveyed both college students and their parents, determined that campus safety

was the second most influential factor in determining a college choice. As a result, crime in the college area should be of great concern to the University of Maryland, since high crime rates may give the university a negative reputation for safety and thus deter prospective students from applying.

On a more individual level, perceptions of a high crime rate can also interfere with people's daily lives. While fear of crime encourages people to better protect themselves against potential danger, excessively high levels of fear can have negative social and psychological effects on people's lives. For instance, research conducted by criminologists Liska, Lawrence, and Sanchirico (1982) has shown that fear of crime can result in heightened anxiety, feelings of alienation, and unwarranted suspicion toward other people. Another team of researchers, DuBow, McCabe, & Kaplan (1979), have also found that perceived high crime can lead to avoidance behaviors that restrict the actions of individuals, such as avoiding certain streets or strangers, which also inhibits their engagement in social activities, such as those that may take place at night or in places perceived to be unsafe (DuBow, et al., 1979; Garofalo, 1981).

In addition, fear of crime can be detrimental to social cohesion within neighborhoods, as interpersonal distrust increases and residents choose to interact less with the people around them. Neighborhoods without a sense of community tend to experience greater amounts of crime because they lack the informal social controls created by public interactions among neighbors (Liska et al., 1982). Thus, high levels of fear of crime can even lead to greater amounts of actual crime; for this reason, perception is a pillar of this study and will complement the raw data of actual crime occurrences. Information on perception will allow a more concrete and qualitative analysis about repeat crime hot spots when drawing conclusions and making recommendations for crime reduction. This study takes a novel, multi-pronged approach through its simultaneous

analysis and combination of the following: survey results that will reflect fear of crime and other aspects of perception, data of actual crime occurrences in the study area throughout the duration of the study, and evaluations of individual properties derived from a CPTED evaluation scale. Combining these items will offer a more holistic picture of the nature of crime in College Park.

Routine Activity Theory

The theoretical model used as the guide for this research is routine activity theory. Routine activity theory states that there are three conditions that account for the occurrence of a crime: a motivated offender, a vulnerable target, and the lack of a capable guardian (Cohen & Felson, 1979; Brantingham, 1981). Instead of focusing primarily on how a criminal's history affects crime, routine activity theory focuses on how these three variables converge to create a crime. This theory can be applied to help analyze "hot spots" of crime (Sherman, Gartin, & Buerger, 1989). According to the theory, if even one of the three aspects of crime is missing or is lessened, the crime cannot, or is at least less likely to occur. Further information about this theory, its application, as well as its benefits and drawbacks to research design is expanded upon in the literature review.

Thanks to a partnership established with the City of College Park, the Prince George's County Police Department, and the University of Maryland Police Department, the researchers identified the impact of the installation of CCTV security cameras in various pre-determined hot spots off campus as the environmental intervention that would be evaluated. Specifically, the researchers sought to assess the effects CCTV had both on resident and non-resident perceptions of an area, as well as crimes committed in the target area. CCTV cameras enhance natural surveillance in an area, add the presence of a capable guardian and serve as a reminder that crime is ever-present. Residents and passersby may, in turn, become more cautious.

Research Questions and Hypotheses

Following an extensive review and analysis of the literature on routine activity theory, perceptions of crime, and the effects of CCTV the following research questions were identified to guide the team's research:

1. What is the relationship between a routine activity-based intervention and the rate of property crime and robberies in off-campus student residential areas?
2. What is the relationship between a routine activity-based intervention and students' perceptions of crime?
3. What is the relationship between crime and the environmental design of properties in the selected area?

Sub-questions of the study are as follows:

- Where are the off-campus student residential areas with high incidences of reported crime?
- What is the specific nature of crime in these hot spots?
- What are students' perceptions of crime—including awareness and fear of crime as influenced by their history of victimization and personal experiences—in the target area, pre-intervention?

The study hypothesizes that following the implementation of a routine activity-based intervention through the CCTV cameras, crime rates will be reduced and students' perceptions

will reflect a greater sense of safety. In addition, it is hypothesized that properties with lower levels of CPTED vulnerability will have fewer incidences of crime. The intervention has both the potential to reduce crime and enhance students' sense of safety for the University of Maryland community and other comparable universities. Even if the findings fail to show a relationship between the intervention and positive changes in crime and perception, the study and methodology are still valuable contributions to research in this field due to the novel combination of crime rates, perceptions, and environmental design in relation to CCTV cameras in off-campus student residential areas. The methodology could be replicated and modified to find a successful way to prevent and reduce crime as well as alter perceptions.

Chapter 2: Literature Review

Overview

Generally, people prefer to live in areas that are not affected by a high level of crime because of decreased personal risk. For community members living in and around the higher education institutions, this is no exception. A poll conducted by College Board (2008), which surveyed both college students and their parents, determined that campus safety was the second most influential factor in selecting a college. As a result, crime in and around the campus should be of great concern to the University of Maryland, since high crime rates may give the university a negative reputation for safety and, thus, deter prospective students from applying. This problem is compounded by the highly competitive nature of the American university system (Campbell & Bryceland, 1998).

At the University of Maryland, crime has decreased from 2006 to 2007. For example, there were 202 burglaries on the campus in 2006, while there were only 91 burglaries in 2007 (US Department of Education, 2009). In 2008, however, the number of burglaries increased to 140, though it decreased to 87 burglaries in 2009 (US Department of Education). Beyond burglaries, general crime rates have remained inconsistent year-to-year, and crime has continued to be a problem for the University of Maryland and other universities throughout the United States. Combined, all universities in the United States have recorded a staggering 25,978 burglaries in 2007 (US Department of Education). In addition, 37 percent of college student respondents reported having suffered from crime victimization (Fisher, Sloan, Cullen, & Lu, 1998). In turn, high rates of crime can decrease student's attendance and participation in social activities, negatively affecting students' college experiences (Barton, Jensen & Kaufman, 2010).

The rate of victimization in areas surrounding a college campus has traditionally been considered higher than the rate of victimization on campus (Fisher et al., 1998). At first glance, crime data from the US Department of Education (2009) for the University of Maryland seems to represent a trend to the contrary. However, this data is misleading because it actually includes both on campus and local off-campus crimes (US Department of Education, 2009). These local crimes are what this study refers to as “off-campus crimes” because there are students that live in these areas in privately rented student housing. Moreover, despite the decreasing on-campus crime rate at the University of Maryland, these students continued to experience a high rate of victimization (Rondeaux, 2007).

As addressed in Chapter 1, local statistics suggest that burglaries, larcenies, and robberies are of much greater concern to students living off campus in the 20740 region than to those living, working, and studying on campus in the 20742 region (Local Explorer, 2006). This research has therefore concerned itself with college students living off campus. As a result, a number of different theories related to crime prevention have been reviewed in order to design the methodology, assess efficacy of interventions, construct measurement tools, and become familiar with prevention and perception of crime. This review of theory and literature included routine activity theory, situational crime prevention, perception of crime, and CPTED.

Routine Activity Theory

Routine activity theory states that there are three aspects to a direct contact crime: a motivated offender, a vulnerable target, and the lack of a capable guardian (Cohen & Felson, 1979; Brantingham, 1981). Instead of focusing on how a criminal’s history affects a direct contact crime, routine activity theory focuses on how these three variables converge to create a

crime. This tenet can be applied to help analyze "hot spots" of crime (Sherman et al., 1989). If even one of the three aspects of crime is missing or is lessened, the crime cannot occur.

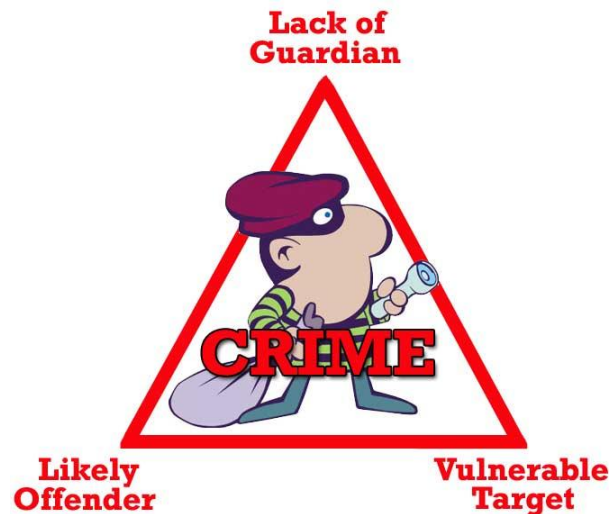

Figure 1: Routine activity theory

It has been noted that offenders' motivations are dynamic and unpredictable (Sasse, 2005). These motivations may take years to build and can change depending on the offender. For example, a sex offender's motivations, according to Fisher (1998), Burgess (1985), and Chesterman and Sahota (1998), can stem from low self-esteem, past sexual abuse, and physical abuse, respectively (as cited in Sasse, 2005, p. 549). Other motivations for the offender can also include drugs and alcohol. Therefore, there are certain motivations, such as the former listed, that exist before a criminal has chosen a victim, and those, such as the latter listed, that arise right before a criminal act is completed (Sasse, 2005).

The suitable target and guardianship aspects of routine activity theory are tied together. A target becomes more suitable when there is less guardianship. Guardianship includes, but is not limited to, surveillance-enhancing techniques, property marking, improved street lighting, neighborhood watch, burglar alarms, and improved locks. Indeed, guardianship can be provided by both citizen-based initiatives as well as by law enforcement.

Nevertheless, the area of guardianship has largely been understudied (Reynald, 2010). One study, completed by Madensen, Tillyer, and Wilcox (2007), studied guardianship at an individual and neighborhood level. Individual guardianship looks at the qualities that relate to social ties and interpersonal control. According to past research, a significant relationship between guardianship and burglar victimization was only found at the individual target hardening and defensible space levels. As expected, there was a positive correlation between the number of household goods, perceived disorder and family income, and the number of burglary victimizations (Madensen et al., 2007). Consistently, guardianship has been shown to be an important facet of determining crime victimization in both the individual and neighborhood (or aggregated) levels (Reynald, 2010).

A “higher intensity of directly observable guardianship during the daytime” has been found to directly correlate to a reduction in crime (Reynald, 2010). This intensity can be measured through observation and determined through actual monitoring and intervention when necessary. The actual decision making process of guardians, which allows them to be capable, has at least three critical dimensions which include willingness to supervise, ability to detect, and willingness to intervene (Reynald, 2010).

When looking into guardianship it is also important to consider other aspects that may interfere with lowering crime rates. Such aspects include attractive household goods such as color televisions, cameras, and motorcycles, all of which make a house more attractive to criminals. It is also important to keep in mind the location of the neighborhood. Crime rates may be different between neighborhoods near schools as opposed to neighborhoods near bars or gas stations. Similarly, one must evaluate any disorder in the neighborhood, such as litter, abandoned homes, and the presence of loitering teenagers. Age, race, sex, and income should

also be taken into account when seeing how guardianship affects crime rates (Madensen et al., 2007).

A routine activity-based intervention may force criminals to move elsewhere, change their crime focus, or alter their tactics. This phenomenon is known as displacement. Any change to make an area a less favorable crime target makes another target elsewhere more favorable in comparison. However, crime displacement is reported at a rate less than 100 percent of the original crime rate, meaning that crime has moved to other areas but occurs at a reduced rate than previously (Gabor, 1990; Clarke, 1995).

The potential downfall of solely displacing crime, instead of preventing it, has become increasingly scrutinized both theoretically and empirically, but is nonetheless overlooked because of the overwhelming presence of quantifiable benefits despite displacement (Town, 2001). Diffusion of benefits is the spread of beneficial elements beyond the directly targeted area (Clarke & Weisburd, 1994). For example, if some houses in an area, especially recent targets, are target-hardened then burglars are deterred not only from these households, but also from all of the households in the area (Pease, 1991). Increasingly, diffusion of benefits has come to be seen as part of an intervention (Clarke, 1995). Although further theoretical study that includes criminal behavior analyses, offender perceptions, and relationships between different private and public space is necessary to better fight crime, so is "practically oriented research" in "particular contexts" (Clarke, 1995, p. 139).

Routine activity theory has also been applied to the college environment in order to better understand campus crime. Studies have found that college students poorly protect their personal property and often fail to shun peers who commit violent crimes. Moreover, students who frequently purchase expensive items increase their risk of victimization (Barton et al., 2010).

For college campuses, routine activity theory has been useful in order to analyze strategies to prevent crime, especially through self-protection. However, because routine activity theory narrowly focuses on opportunities or risks concerning crime, these studies have trouble characterizing how social structure relates to crimes (Barton et al., 2010).

Situational Crime Prevention

Situational crime prevention refers to a measure taken to reduce opportunities for crime by increasing risks and reducing rewards; this scheme includes a framework, a methodology, and a set of opportunity-reducing techniques (Clarke, 1995). The advantage of situational crime prevention over CPTED is a broader focus. Whereas CPTED focuses on place design, situational crime prevention hopes to reduce crime through many aspect-oriented interventions; as such, situational crime prevention can actually include CPTED-based interventions (Clarke & Elliot, 1989).

Situational crime prevention also gains strength from its practical approach. For example, a sociology-based approach would try to address why an offender is committing a crime, which is impractical. This is simply “outside of the sphere of influence of any criminal justice systemic body” (Hummer, 2004, p. 394). Instead, situational crime prevention contains rational choice, environmental criminology, and routine activity theory in order to create defensible space. This defensible space, in turn, refers to forming a physical area such that its elements help promote security, much like CPTED. Situational crime prevention, then, functions as a “reactionary theoretical perspective” (Hummer, 2004, p. 411).

Of particular interest is the standard action research methodology associated with situational crime prevention (Lewin, 1947). This methodology consists of five steps (Gladstone, 1980; Clarke & Elliot, 1989):

1. Collection of information about a particular crime;
2. Analysis of the situational conditions that permit this crime;
3. Systematic study of preventative measures with cost analysis;
4. Implementation of the best measures (in terms of economics, feasibility, and promise); and
5. Determination of results.

Although one may approach crime from the behavior side by addressing punishments, this methodology could be adapted to increase difficulties associated with committing crimes.

Studies guided by situational crime prevention have encountered both crime displacement and diffusion of benefits. Although early research claimed displacement of crime to nearby areas, later research has asserted that crime displacement rarely happens (Guerrette & Bowers, 2009). In fact, according to a recent review, diffusion of benefits is largely possible while displacement is rarely reported in various situational crime prevention based studies (Guerrette & Bowers, 2009). In the context of a college, the possible diffusion of benefits, alongside the preventative power of its methodology, makes situational crime prevention the best option for crime prevention on campuses. Moreover, the tenets of situational crime prevention can help to ameliorate perception of crime (Hummer, 2004).

Crime Prevention through Environmental Design (CPTED)

Many research studies conducted in the latter half of the 20th century have substantiated CPTED's effectiveness as an intervention to reduce crime, and its potential to increase property value (Cozens, Saville, & Hiller, 2005). Moreover, CPTED's particular approach to crime prevention as an umbrella intervention allows for adaptation of theoretical principles to specific locations. However, the common sense environmental design strategies that comprise CPTED have come under a great deal of scrutiny (Crowe, 2000). This scrutiny has led to a new generation of CPTED, referred to as "community CPTED," that takes a more holistic approach to crime prevention, including both external and internal environmental elements.

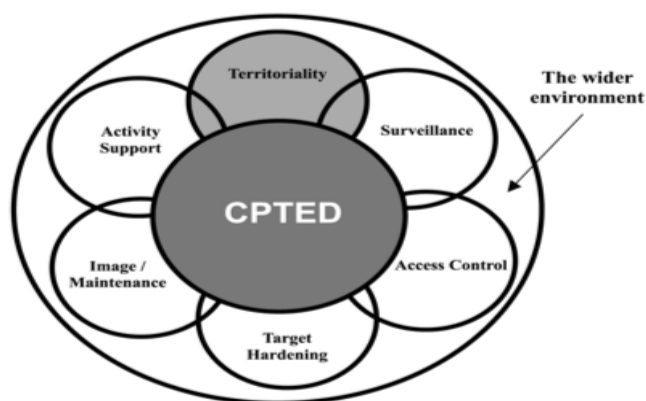

Figure 2: An illustration of CPTED's first generation's six principles; note that they overlap with one another to form CPTED as a whole (Cozens et al., 2005).

Instead of focusing solely on the external environmental factors, meaning the physical environment, "community CPTED" uses evaluation of social factors, or internal environmental factors, in the form of risk assessment and socioeconomic and demographic profiling to improve community cohesion and activity (Carter, 2002; Sakissian, Perglut, Ballard, & Walsh, 1994; Saville, 1995). Originally, traditional CPTED was based on six overlapping principles: territoriality, surveillability, target hardening, access control, activity support, and image or

maintenance (see Figure 2). However, without social context, these interventions are not nearly as effective. The current generation of CPTED addresses these concerns (Cozens et al., 2005).

Territoriality refers to the effort to instill a sense of ownership in the users of semi-private and private space. Encouraging ownership discourages the presence of people who do not belong there. Territoriality methods include actual barriers, such as fences, and symbolic barriers, such as signs. Both actual and symbolic barriers define areas and separate public from private space (Riegel, 2002).

Indeed, the research conducted has led to the common consensus that enhanced levels of territoriality are linked to reduction of crime and fear of crime (Cozens et al., 2005). Moreover, territoriality is especially effective when conducted at the local level, although definition and control of areas are difficult and dependent on the heterogeneity of people populating an area (Taylor, 1988; Ratcliffe, 2003).

CPTED also consists of surveillability, which is the effort to increase the visibility of an area, thereby allowing informal or natural surveillance to occur. Surveillability works off of the basic premise that people are less likely to commit crimes when someone is watching. In fact, high levels of surveillance and occupancy are the most important factors in determining a burglar's target (Bennett & Wright, 1984). Informal or natural surveillance is typically residents' self-surveillance, which can be increased by sufficient lighting, low walls, and well-maintained shrubbery (Weisel, 2002).

Research in the past few decades has successfully explored the efficacy of lighting as an intervention. A review of CPTED data concerning improved lighting found a crime reduction of 7 percent in the United States and 30 percent in Great Britain in methodologically sound studies; this data additionally revealed that the loss of property due to burglary made it worth investing in

lighting (Farrington & Welsh, 2002). However, some efforts to increase visibility have not increased informal surveillance (Barr & Pease, 1992). Other measures that could be implemented include formal surveillance, which is hired surveillance, and mechanical surveillance, which is artificial surveillance, such as by camera (Clarke, 1995). Although novel, using social aspects with surveillance efforts, such as the construction of a common area for residents to increase informal visibility, still requires further testing. However, a community's social aspects, such as cohesion and activity, present a necessary consideration when researchers consider surveillance-based interventions (Laufer, Adler, & Mueller, 1999).

Target hardening is another aspect of CPTED. A target hardening intervention would involve the use of physical barriers, such as deadbolt locks, screens, and barred windows, in order to obstruct an intruder's entry (Clarke, 1995). However, some studies have found that since only a limited number of burglaries are forced entry, ease of entry is not as important of a factor as level of occupancy because of higher risk of detection (Bennett, 1989; Budd, 1999). Nevertheless, target hardening security measures have reduced burglary in a variety of settings internationally (Sorenson, 2003; Tseloni, Wittebrood, Farrell, & Pease, 2004). Even though burglars state that locks may not always deter them, they admit that difficult locks may force them to choose another more vulnerable target (Bennet, 1989).

Access control refers to measures taken in order to restrict the entry of potential offenders from particular locations (Clarke, 1995). These measures can consist of placing security at entry points in organized access control, defining spaces in natural access control, or using mechanical access control with locks (similar to target hardening). Typically, measures promoting more pedestrians and more regulated access will reduce burglaries and crime in general, respectively (Poyner, 1992; Eck, 1997). Although access control is a typical intervention in urban or high

crime areas with homicide or prostitution, access control can work in residential areas depending on the site itself. For example, grouped housing units may present the ability to construct a lobby or to improve pedestrian traffic nearby (Cozens et al., 2005).

Activity support refers to the use of design elements in order to enhance community interaction and promote the intended use of an area, protecting vulnerable people. Often, increasing sheer traffic increases safety, however, this effect depends on the site and type of traffic (Cozens et al., 2005).

Image, or maintenance, refers to promoting a positive image through maintenance and care of an area. In residential areas, maintenance reflects and promotes social cohesion (Lewis & Salem, 1986; Kelling & Coles, 1996). Moreover, lack of social cohesion increases fear, and signs of disorder in the area correlate with crime targeting that area (Perkins, Florin, Rich, Wandersman, & Chavis, 1990; Covington & Taylor, 1991).

Each of these six aspects of CPTED has successfully reduced crime, or at least a particular type of crime, as well ameliorated perception of crime (Cozens et al., 2005). All of these physical aspects of CPTED come together to influence the social nature of a neighborhood. Indeed, the effectiveness of some aspects of CPTED, such as territoriality, depends on residents. For example, CPTED can create a fortress when it is implemented without consideration for others, causing people to withdraw and weakening social interaction (Cozens et al., 2005). In order to prevent this from occurring, researchers have begun to incorporate social aspects into CPTED.

The social aspects of CPTED include tipping point (decline leading to out-migration), social cohesion, connectivity, and community culture (Saville & Cleveland, 2003). Each of these addresses the community as a whole, relating back to the cohesiveness of the community.

One way people have successfully increased social cohesion is through maintenance of the environment and when people are less cohesive as a community, fear is more prevalent (Cozens et al., 2005).

One particular study used local friendship networks, control of local teen gangs, and participation in organizations in order to quantify social cohesion, and found that low levels of each of these variables were correlated with communities with “disproportionately high rates of crime and delinquency” (Sampson & Groves, 1989, p. 27). Efforts to increase social cohesion address the problem of social disorganization, which is the inability of the community to holistically accept values and keep social controls or norms (Kornhauser, 1978; Sampson & Groves, 1989). These efforts are based on the measurement of prevalence and interdependence of informal and formal social networks and supervision of local problems (Sampson & Groves, 1989).

For researching crime in communities the “block” structure is of particular interest as boundaries are easily defined, fairly culturally heterogeneous, and crime prevention techniques work best in smaller social units. The use of blocks brings up the ecological validity of a study, which refers to how accurately the researchers define the boundaries of their unit of study (Perkins et al., 1990). For the physical environment of individual houses, this may not be important, but from a social based standpoint, ecological validity ensures you are measuring one social unit.

The concepts of CPTED are by no means independent. There is a great deal of overlap in interventions, where many can fall into multiple categories. Moreover, these cannot be considered only within the context of crime prevention. The aesthetics of the intervention are also important, which has led to the creation of “design against crime” in recent years, which

strives to work with residents to eliminate crime through effective design (Gamman & Pascoe, 2004). It is important to keep in mind the social context in which each of these changes are made, as without community involvement, physical changes may not work effectively (Barr & Pease, 1992).

Perception of Crime

One important aspect of crime perception is fear of crime. Fear of crime is a multi-faceted concept that can be organized into three states: the conscious experience of feeling fearful, the cognitive recognition that a situation is dangerous or threatening, and avoidance and protective behaviors, which may be intentional, unintentional, or physiological (Gabriel & Greve, 2003).

The concept of fear of crime has not been universally defined due to varying interpretations of what defines fear, emotions, and feelings. Garofalo (1981) defined fear as an emotional response to an increased sense of danger brought forth by the threat of physical harm. Garofalo (1981) and Maxfield (1984) both supported the view that violent crimes instigate fear and property crimes cause worry (Taylor & Hale, 1986). Garofalo, however, did recognize that property crimes may also elicit fear in cases such as the theft of valuable items or the possible confrontation with a thief. In another study, Gabriel and Greve (2003) defined fear of crime as an individual's fear of becoming victimized by crime. Fear of crime may be defined depending on what precise variables are measured such as perceptions of risk, fear of victimization, general perceptions of crime, and levels of anxiety.

Fear of crime can lead to a wide variety of responses. DuBow and colleagues (1979) categorized these responses into six different types of behaviors: avoidance, protective,

insurance, communicative, participation, and information seeking (as cited in Garofalo, 1981). The two behaviors that have been measured in research studies more prevalently are avoidance behaviors and protective behaviors. Avoidance behaviors are those that reduce one's exposure to crime by avoiding one's risk of victimization, such as avoiding strangers or avoiding certain areas at night (Liska, et al., 1982). Avoidance behavior has a significant impact on a person's participation in social activities. Garofalo (1977) found in a national crime survey that 27 to 56 percent of respondents in 13 cities limited their activities due to crime. Furthermore, Garofalo (1977) found a gamma of 0.55 between fear of crime and one's social life. Research has also suggested that fear of crime may result in negative psychological effects, such as increased anxiety, mistrust, alienation, and dissatisfaction of life. Protective behavior, on the other hand, involves the implementation of protective programs to reduce one's risk of victimization, such as installing home security locks, carrying personal firearms, learning self-defense skills, and buying watchdogs (Liska et al., 1982).

In terms of neighborhood cohesion, Conklin (1975) found that fear of crime produces negative social outcomes such as heightened distrust among neighbors, apathetic support towards central authorities devised to reduce crime, and decreased social interaction (Garofalo, 1981). These outcomes, in general, may lead to weakened informal social controls within an area and ultimately may lead to higher crime levels (Garofalo, 1981).

Research has shown that certain demographic variables have a positive correlation to increased fear of crime. Grabosky's study (1995) found that women, the elderly, lower income residents, crime victims, those who have been exposed to negative crime media, and those with low confidence in police experienced heightened fear of crime. Residents in neighborhoods characterized by minorities, youth populations, and transients also experienced higher levels of

fear. Research has also illustrated that there is a correlation between one's sense of community and one's fear of crime. Greenburg, Rowe, and Williams (1982), for instance, found that an emotional attachment to one's neighborhood was an important element of social control in that neighborhood (as cited in Schweitzer, Kim, & Mackin, 1999). Hunter (1978) also suggested that social disorganization, which stems from community decline, results in social and physical incivilities and crime (as cited in Taylor & Hale, 1986). In a study measuring physical and social variables in 44 urban residential neighborhoods, Schweitzer et al. (1999) found a strong negative correlation ($r = -0.597$) between fear of crime and a sense of community.

Previous studies have used a wide variety of fear reduction programs, some of which were more successful in reducing fear of crime than others. Moore and Trojanowicz (1988) found that increased police foot patrol and police community newsletters that described accurate crime information in the residential neighborhoods all successfully reduced citizens' fears. This may have been the case because these programs created a closer contact between the residents and the police community. Newsletters organized by the Houston Police Department from 1983 to 1984, on the other hand, did not appear to have reduced levels of fear of crime. However, other interventions that were implemented by the Houston Police such as community organizing, police community stations, and a citizen contact patrol were more successful in reducing levels of fear of crime (Grabosky, 1995). A program implemented by Fisher (1993) involving block watch meetings and crime prevention seminars found that residents who participated in the block watch meetings experienced increased social cohesion and decreased fear of crime while those who participated in crime prevention workshops did not.

CCTV as a CPTED Approach

As previously mentioned, CPTED incorporates the aspects of surveillance into crime prevention, considering deterrence of crime by formal surveillance provided by personnel on-site and lighting that inherently enhances visibility. Another aspect of formal surveillance is Closed Circuit Television (CCTV). Recently, this technology has gained public interest not only due to its widespread use, but also for its use for prevention of terrorist activities, such as in New York City (Welsh, 2009). CCTV can detect not only potential terrorism, but also other crimes that happen within the range of view of cameras. CCTV is therefore able to work as a crime prevention strategy.

CCTV works with cameras through a combination of deterrence, detection, and the presence of a capable guardian. Through deterrence, CCTV can work by increasing the perceived level of risk for the offender (Cozens et al., 2005). For instance, by committing a crime in an area with cameras, one is risking a greater level of detection than in an area without cameras. Moreover, the perceived risk may now outweigh the potential benefit, thereby deterring a potential offender. Detection is similar in nature to deterrence. Because CCTV cameras may record images that lead to a criminal's arrest, crime could be reduced because some offenders will inevitably be caught. Moreover, CCTV can lead to an increase in foot traffic and help police interfere to prevent crimes (Welsh & Farrington, 2009). Finally, the presence of a guardian prevents a capable offender from initiating a crime upon a vulnerable target, according to routine activity theory. Although there have been successes that reflect these strengths, a thorough discussion of CCTV must be qualified by the recent inception of cameras. Indeed, CCTV has only come into widespread use within the past two to three decades (Armitage, 2002).

CCTV theory is further tempered by the interaction of residents affected by CCTV (Gill &

Loveday , 2003). It is generally assumed that CCTV will not only lead to residents being more careful in their routines, but will also encourage guardianship by these residents. However, when not in public or when not well known by the population, these benefits of CCTV can be eliminated, or worse, changed into detriments. For example, cameras can lead to a false sense of security in some residents, which may lead to some people no longer taking precautions to avoid crime (Welsh, 2009). Moreover, if the cameras are ineffective due to technological problems or poor lighting, their ability to reduce crime may also be eliminated (Gill & Loveday, 2003; Farrington, Gill, Waples, & Argomaniz 2007). Even when effective, cameras may cause an increase in reported crime simply by encouraging increased reporting and by increased detection of crime (Welsh, 2009). Finally, there is also the problem of displacement of crime. Recent studies have suggested that there exists a sporadic tendency for crime to be displaced from areas when CCTV is installed. However, this displacement usually occurs locally, suggesting a uniform CPTED approach may solve this problem (Waples, Gill, & Fisher, 2009).

There is a large body of research supporting CCTV's efficacy. However, the correlation between crime and CCTV can be considerably inconsistent. Some crimes—property crimes and vehicle property crimes—are much more likely to be reduced by the placement of cameras (Welsh & Farrington, 2004; Cozens et al., 2005). On the other hand, many other crimes are not significantly affected by camera placement, and CCTV's effects can further be obscured when alcohol is involved (Cozens et al., 2005). Researchers have found that through inebriation of people who frequent an area, the theoretical perceived discouragement of crime is effectively erased; this relationship between alcohol and crime cannot be ignored within a college community (Cozens et al., 2005). The problem in discerning the efficacy of CCTV is further compounded by placement. In some arenas, CCTV has only found limited success. For

instance, implementation of CCTV has limited reduction of crime in public housing areas (Pawson & Tilley, 1997). Although fear of crime is generally reduced, which improves the perception of crime within an area, the effect may change over time. In fact, the perception of residents can actually worsen over time because unless there is an ongoing public awareness campaign regarding the CCTV cameras, the benefits provided by cameras over the long run may disappear (Armitage, 2002; Brown, 1995). This could be a pitfall in an area with rapid turnover, since the rapid change of residents makes it inherently harder to maintain awareness. Because of the variability of CCTV's efficacy, cameras must be evaluated on a case-by-case basis. In any research, CCTV needs to be tested at certain locations and different conditions to determine if it is truly effective (Wilson & Sutton, 2003).

When combined with lighting changes, CCTV has been found to reduce crimes. However, such a decrease could potentially be limited to certain high visibility crimes, such as vehicle theft (Welsh & Farrington, 2004). Research has been far from conclusive in this arena. Speculation for the lack of conclusive power in this arena include multiple confounding variables in associated study, including other changes affecting crime rate, as well as counter-intuitive changes in activities because of cameras (Armitage, 2002; Williams, 2007). Cameras may also skew actual crime prevention because camera operators may focus their attention towards stereotypically suspicious profiles (Williams, 2007). Indeed, many of the studies have been executed over sort time scales, which limits their conclusive power and confounds the results (Armitage, 2002). In fact, when reviewed, CCTV research overall lacked conclusive power in its ability to reduce crime: in the UK, CCTV only had a small reduction in crime that was most pronounced on vehicle theft (Welsh & Farrington, 2009).

Chapter 3: Methodologies and Methods

Methodology

This study is a longitudinal case study of Old Town College Park, an off-campus student residential area, following an interrupted time series design. The installation of a security camera system in Old Town College Park serves as the interruption of the study. The installation of a security camera system also serves as the main CPTED intervention of the study. This interruption is preceded by a pre-intervention survey and followed by a post-intervention survey. Continuous data collection is incorporated into the design since before the pre-intervention survey until after the post-intervention survey (see Figure 3).



Figure 3: Research design

Sample

The sample area was chosen using crime data provided by the Prince George's County Police Department and by the use of spatial statistics tools. Seventy percent of crimes reported between January 2007 and September 2008 were geo-coded onto a map using ArcGIS, a

geographic information system technology. The other 30 percent of the data contained spelling errors or data omissions and thus these records could not be matched to the map layer.

District One of Prince George’s County was the main district of interest for this crime assessment because it includes the city of College Park and the University of Maryland. Results from the geo-coding showed that burglaries, larcenies, and robberies occurred in higher frequency in District One than all other reported crimes. As a result of this finding, the researchers chose to focus solely on these crimes. Clusters of these specific crimes were determined through use of the CrimeStat Spatial Statistics Program, which takes into account the proximity between crimes as well as the frequency of incidents within a location. This program identified Old Town College Park as an area that experienced a relatively high level of crime in District One (see Figure 4). The concentration of burglaries, larcenies, and robberies within Old Town led to the selection of this neighborhood as the target sampling area.



Figure 4: Crime hot spot in College Park

The sample area was more narrowly defined to the neighborhood demarcated by the red lines in Figure 4 in order to exclude commercial activity along Baltimore Avenue and to place

more attention on crime rates in the residential neighborhood. Differences between commercial and residential areas in environment and in the nature of crimes committed resulted in the omission of streets near Baltimore Avenue from the sample area.

The population includes residents of the selected area and University of Maryland students who did not reside in the area (non-residents); the target group is University of Maryland students because they comprise a large proportion of tenants in this area. Furthermore, this location’s proximity to the College Park metro station, student-occupied housing, and businesses located along Baltimore Avenue make this region a frequented area for university students.

Convenience sampling was utilized to recruit participants for the survey. Residents and non-residents were asked to complete the survey through advertisements in listservs, flyers, Facebook, and the research team website. This sampling method was the most cost-effective. Furthermore, this technique allowed for a larger sample size.

Demographics	Residents		Non-Residents		All	
	Pre-Survey	Post-Survey	Pre-Survey	Post-Survey	Pre-Survey	Post-Survey
N	85	110	354	163	439	275
Median Age	21	21	20	21	20	21
White	76.5%	76%	65%	69%	67%	72%
Non-White	23.5%	24%	35%	31%	33%	28%
Males	48%	44%	37%	29%	39%	35%
Females	52%	56%	63%	71%	61%	65%

Table 1: Characteristics of samples

The total sample for the pre-intervention survey, conducted in the fall of 2009, which included 439 participants, was 67% White and 33% non-White. The median age for both genders was 20, and the mean age was 21. The gender breakdown of the respondents was 39% male and 61% female. For the resident sample, the racial composition of the residents was

76.5% White and 23.5% non-White. The median and mean ages were 20 and 21, respectively. The gender breakdown was 48% male and 52% female. As for the non-resident sample, the racial breakdown was 65% White and 35% non-White. The median age was 20, and the mean age was 21. The gender composition was 37% male and 63% female.

For the post-intervention survey, conducted in the fall of 2010, there were a total of 275 respondents, 72% of whom were White and 28% of whom were non-White. The median and mean ages for both genders were 21 and 23. The proportion of male and female respondents was 35% and 65%, respectively. The racial and gender make-up of the resident sample was similar to that of the resident sample from the pre-intervention survey. 76% of the residents were White and 24% were non-White. The gender composition was 44% male and 56% female. The median and mean ages were 21 and 22. Lastly, the racial and gender breakdown of the non-resident sample was 69% White, 31% non-White, 29% male, and 71% female. The median age was 21, and the mean age was 20.

The demographic information available for the blocks in this neighborhood date back to 2000 and were collected by the US Census Bureau for the decennial census. The data shows that the population of the target area was 85% White and 15% non-White. The median age for both genders was 23, and the mean age was 28. The gender breakdown was 53% male and 47% female.

Information about University of Maryland student demographics for the fall of 2009 and the fall of 2010 was released in enrollment reports by the Institutional Research Planning and Assessment. In the fall of 2009, the racial composition of both undergraduate and graduate students was 56% White and 44% non-White. The median age and mean age were 21 and 28, respectively, and the gender breakdown was 52% male and 48% female. In the fall of 2010, the

racial composition of all students was 56% White and 44% non-White. Males and females made up 53% and 47% of the population, respectively. The median age was 21, and the mean age was 28.

The chi-square test shows that there are no significant statistical differences between the Old Town resident population and the sample of Old Town residents in terms of racial and gender composition in the pre-intervention survey. The post-intervention survey resident sample does not significantly differ in gender from the Old Town resident population but does differ significantly in racial composition. For both the pre-intervention survey and post-intervention survey, the median age of the samples (21) is similar to the median age for the resident population (23). The survey's lower median age by two years is reasonable since a large number of undergraduate students have recently become tenants in the neighborhood, and the median age for undergraduate students at the University of Maryland is 21 (Office of Institutional Research, Planning & Assessment, 2010).

It is possible that the population statistics for Old Town may have changed since the decennial census was conducted in 2000. Nevertheless, given that Census data is the only information available, it is still useful for making comparisons between the sample and the target population.

Comparisons made between the University of Maryland student population and the non-resident sample for both pre- and post-intervention surveys using the chi-square test show that there are significant statistical differences between the population and the sample that are not due to chance. In particular, the chi-square test confirms significant disparities in racial and gender compositions. Compared to the population, the sample had more White participants than non-White participants. Furthermore, females were more represented in the survey sample than in

the population. This disproportion may be because females were more willing to participate in a survey about crime. Research has shown that females tend to be more fearful of crime than males, and this fear may have influenced more women to participate in the survey (Grabosky, 1995). Lastly, for the pre-intervention survey non-resident sample, there is only a one-year age difference between the median age of the pre-intervention survey non-resident sample (20) and the median age of the University of Maryland student population (21). When comparing the median age of the post-intervention survey non-resident sample with the University of Maryland fall 2010 student population, there is no age difference; the median age for both the sample and the population is 21.

Comparison of Samples with Respective Populations				
	Pre-Survey		Post-Survey	
Demographics	Non-Resident Sample vs. UMD Population	Resident Sample vs. Resident Population	Non-Resident Sample vs. UMD Population	Resident Sample vs. Resident Population
Race	Reject H _o	Accept H _o	Reject H _o	Reject H _o
Gender	Reject H _o	Accept H _o	Reject H _o	Accept H _o
Median Age	20 vs. 21	21 vs. 23	21 vs. 21	21 vs. 23

Table 2: Comparison of samples with respective populations

Based on these analyses, it was concluded that while the non-resident sample is not representative of the population, the resident sample—which of the two samples is the more important one for this research because residents better understand the target area than non-residents—is fairly representative of the resident population based on race, gender, and age. It is important to note that while the two samples are not perfectly representative of their respective populations, the pre and post samples for both residents and non-residents are very similar,

which confirms that any differences in the results cannot be attributed to any differences in the samples.

Independent Variables

The chief independent variable in this study is the placement of security cameras within the area of interest. On February 23, 2010, the College Park City Council approved a contract with the technological solutions provider, Avrio Group Surveillance Solutions, LLC, to coordinate the installation of cameras along Baltimore Avenue, Knox Road, and other streets within the Old Town neighborhood. The system became operational on October 29, 2010.

The cameras connect wirelessly with the Security Operations Center (SOC) of the University of Maryland Department of Public Safety, adding to the current network of over 500 cameras on the university campus and in some areas of College Park (see Figure 5). The SOC staff provides live, 24-hour monitoring of the feeds throughout the year, including during holidays and university vacations. Additionally, digital video recording equipment retains footage for later review if necessary.



Figure 5: The Security Operations Center surveillance monitoring room.

The SOC can communicate with officers on patrol through the police radio units, allowing for immediate response to events that occur within a camera's field of view. Cameras can tilt, pan 360°, and use optical/digital zoom (see Figure 6).



Figure 6: One of the surveillance cameras placed on the University of Maryland campus, capable of full tilt, 360°pan, and optical/digital zoom.

The approved proposal called for the installation of 13 surveillance cameras (see Figure 7). Of these, nine are located within the area of interest in Old Town College Park, while one more is within view of the area and may be used to monitor events at the perimeter (see Table 3). Additionally, one previously existing camera is located at the intersection of Hopkins Avenue and Norwich Road.

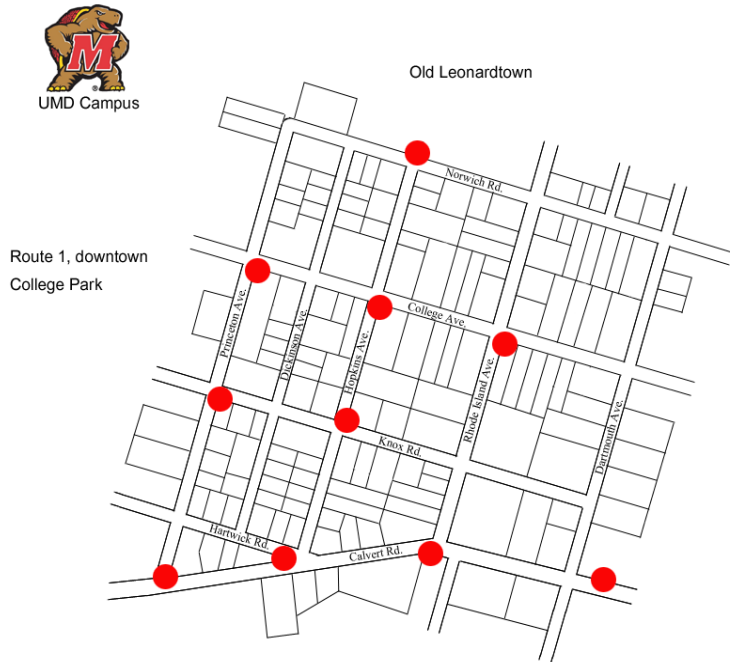

Figure 7: The locations of security cameras in Old Town, College Park

#	Location
1	College Ave x Princeton Ave
2	College Ave x Hopkins Ave
3	College Ave x Rhode Island Ave
4	Knox Rd x Princeton Ave
5	Knox Rd x Hopkins Ave
6	Calvert Rd x Princeton Ave
7	Calvert Rd x Hopkins Ave x Hartwick Rd
8	Calvert Rd x Rhode Island Ave
9	Calvert Rd (east of Dartmouth Ave)
10	Hopkins Ave x Norwich Rd

Table 3: Camera sites inside the Old Town area of study.

Camera locations were proposed to the City Council based on spatial analysis crime density, including the analysis described above. The cameras were also placed to follow the Safety Corridor, a route designed to incorporate lighting, Public Emergency Response

Telephones (PERT), landscaping, and police patrols to provide a safer area for students to walk from the University of Maryland campus to the College Park Metro Station. As described above, the crime density map produced in ArcGIS was used to confirm the relatively high level of incidents in the Old Town College Park, particularly along Knox Road.

CPTED Scale

A property evaluation scale was developed based on the principles of CPTED. CPTED can be used to reduce crime and fear of crime through its six basic strategies of surveillance: access control, target hardening, image or maintenance, activity support, and territoriality (Cozens, 2005). The scale is divided into seven sections—lighting, yard maintenance, home exterior maintenance, accessibility of valuables, territoriality, guardianship, and visibility/sight lines—that assess the physical characteristics of a property according to the six basic CPTED strategies (see Appendix A). These categories were drawn directly from the CPTED literature in order to ensure the measure’s construct validity.

Each property received a score in each of the seven sections of the scale that reflects its CPTED weaknesses and physical vulnerabilities in the spring and fall of 2010. These seven individual scores were then averaged together to determine the overall CPTED score for each property. The higher a property’s score is, the more CPTED weaknesses and physical vulnerabilities it displays. The scores of all the properties were grouped into three categories—“high,” “middle,” or “low”—according to the severity of CPTED vulnerability displayed.

To complete the CPTED evaluations of each property, four researchers visited the target area during the day and scored properties on all sections of the scale except lighting, which was completed at night. In order to ensure consistency in scoring, the four researchers compared their scores on 15 properties and found 93% agreement.

Before the development of the CPTED scale and the completion of CPTED evaluations, a CPTED site assessment was completed to gain familiarity with the target area. The site assessment consisted of a list of items that reflected CPTED guidelines also based on the six basic CPTED strategies, and it allowed for the evaluation of the physical vulnerabilities of Old Town College Park as a whole. To accompany the site assessment, each property within the target area was photographed and cataloged. The site assessment served as a preliminary version of the CPTED scale, allowing the identification of patterns in physical vulnerabilities, familiarization with the environmental design of the area, and gathering of the information necessary to design the final CPTED scale.

Dependent Variables

Records of crimes committed in Old Town College Park starting from January 2008 were obtained on a regular basis from the Prince George's County Police Department. Property crime and robberies were examined.

Property crime, as defined in the FBI's Uniform Crime Reporting (UCR) Program, "includes the offenses of burglary, larceny-theft, motor vehicle theft, and arson" (Department of Justice, 2006). Specifically, burglary, larceny, and robbery were examined. The category of arson was excluded because according to the UCR Program, there is limited participation and several varying collection procedures employed by local law enforcement agencies for the determination of arson, thus jeopardizing the standardization of the measurements. Robbery is technically not considered a property crime by the FBI, but it was included in the data analysis because it is still the "taking or attempting to take anything of value from the care, custody, or control of a person or persons" (Department of Justice, 2006). The only difference between

robbery and regular property crime is that robbery is the taking of something by force or threat of force directly from the victim and property crime includes no direct force.

For each of the selected crimes that occurred in the target area, police reports were collected and analyzed. The crime reports were coded for relevant details, such as location, date, and time, according to a coding protocol developed by the researchers (see Appendix D).

The second dependent variable of the study was perception of crime, as gauged by responses to a survey distributed before and after the camera implementation. This survey was developed based on previously established questionnaires used in studies measuring respondents' perceptions of crime (e.g. Del Carmen, 2000; McConnell, 1997; Wilcox, Jordan, & Pritchard, 2007; Reed & Ainsworth, 2007; Jennings, Gover, & Pudrynska, 2007).

Based on these studies, survey questions were chosen from a variety of categories related to crime experiences and preventative factors (see Appendices B and C). For instance, questions about the respondents' prior victimization experiences were included in order to see if these incidents affected a person's perception or fear of crime. Respondents were also asked whether they reported such incidents and their reasons for reporting or not reporting. Related to these questions were others evaluating the effectiveness of policing in the area, which were incorporated in order to gauge perceptions of security based on police presence and efficiency.

A category related to CPTED principles included questions about the presence and use of protective measures such as door locks and peepholes, as well as questions on the perceived effectiveness of security cameras. This was considered to be valuable information, considering the fact that the CPTED intervention implemented in this study was the installation of security cameras in the Old Town area. In addition, questions about trust and friendliness among neighbors measured the level of social cohesion in the area, and a category of avoidance

behavior determined what actions individuals take to protect themselves. To compare with the particular crimes being studied through the researchers' crime incident data collection (robberies, larcenies, and burglaries), questions involving specific types of crime and causes of crime were also included in the surveys. Finally, several questions were asked to determine the participants' general levels of fear and perceptions of the likelihood of crime (see Appendices B and C). Altogether, the combination of these categories and specific questions was determined in accordance with the main goal of the survey, which was to establish the relationship between perceptions of crime and four main factors: demographic background, prior victimization, CPTED use, and social cohesion.

The format of the survey questions varied by item and included a combination of open-ended questions, single-option questions, checklist items, and Likert-scale items. Since the wording, response options, and even the scaling range of a question can greatly influence a respondent's way of answering, a mixture of different question formats was elected in order to minimize any potential bias caused by the particular style of question. The majority of the Likert-scale items contained 5 levels, with "1" signifying the most negative response (such as "Not at all" or "Strongly disagree"), "5" signifying the most positive response (such as "Very much so" or "Strongly agree"), and the central value of "3" representing a neutral response. Certain Likert-style questions had an increased number of response options (e.g., 1 to 10) in order to allow for a more accurate measure of general phenomena such as overall fear of crime or perceptions of crime likelihood. Other Likert-style questions merely had four response options in order to eliminate the possibility of a neutral response, so respondents would have to decide whether they are worried about crime.

In order to study the perceptions of non-residents and residents of the Old Town College Park area, two versions of the survey were created in order to accommodate both groups. The non-resident survey contained nearly the same set of questions as the 39-item resident survey, with the exception of 11 questions that were removed because they were relevant only to the residents' particular Old Town properties. Additionally, two questions were asked only of non-residents in order to gauge their familiarity with Old Town based on how frequently they have visited the area.

Once the survey design was developed and the specific questions for each survey in this study were selected, the proposed surveys were sent to the Institutional Review Board (IRB) for approval. The surveys were approved in May 2009, and an addendum to this proposal was later approved in September 2009. The addendum included further details of the survey distribution methods and eliminated the initially proposed monetary incentives for participation.

After obtaining IRB approval, an online version of the surveys was created using the Internet-based program, SurveyMonkey. This program offers users the ability to design, edit, and distribute surveys. In addition, the program allows users to collect survey responses and conduct preliminary analysis on the response data, such as by presenting frequency distributions for each survey question. The program also allows the exportation of spreadsheets containing all response data, which can be used to conduct more detailed, descriptive, and inferential statistical analyses. Due to these available functions, SurveyMonkey simplified the survey-conducting process and enabled a wider range of participants to be reached, since participants could access the survey easily by clicking on a specific link on the main page of the research team's website. The site contained one link for non-residents and another link for residents, who were also offered a hard copy of the survey during door-to-door recruitment. As a result of this online

option, more survey responses were acquired than if paper surveys alone had been used, primarily because it enabled the researchers to reach out to the wider community of non-residents, and also served as another way for residents to take the survey if they were unable to take the paper survey during door-to-door rounds. For the post-intervention survey, another Internet-based program called Google Survey was used because it had a more user-friendly interface while still offering similar functions to SurveyMonkey.

Pre-Intervention Survey Respondents

Prior to the implementation of the CCTV camera intervention, paper surveys were administered to residents over a span of several weeks in the months of October and November of 2009. In addition, the online surveys were opened for both resident and non-resident respondents on October 2, 2009, and both were closed on December 11, 2009. During this two-month collection period, a total of 89 Old Town residents and 360 non-residents responded to their respective surveys, either online or in person. However, only 68 of the 89 resident responses were complete, with the others missing answers to at least half of the questions. Similarly, 303 out of the 360 non-resident responses were complete. Possible reasons for incomplete responses are explored in the “Limitations” section of Chapter 5.

Post-Intervention Survey Respondents

After the implementation of the CCTV camera intervention, paper surveys were administered to residents over a span of several weeks in the months of October and November of 2010. In addition, the online surveys were opened for both resident and non-resident respondents on October 29, 2010, and both were closed on December 5, 2010. During this two-month collection period, a total of 111 Old Town residents and 164 non-residents responded to their respective surveys, either online or in person.

Chapter 4: Results

In this chapter, the results are presented. The crime statistics, survey responses, and CPTED vulnerability scores for Old Town properties are first described in detail. These data are then used to test the three hypotheses presented in Chapter 1.

Crime Statistics

From January 2008 to February 2011, 169 burglaries, larcenies, and robberies were reported to police as having occurred in Old Town College Park. The most frequent type of crime was larceny (94 incidents), followed by burglary (60 incidents), and lastly by robbery (15 incidents). The percentage breakdown for larcenies, burglaries, and robberies was 56%, 35%, and 9%, respectively.

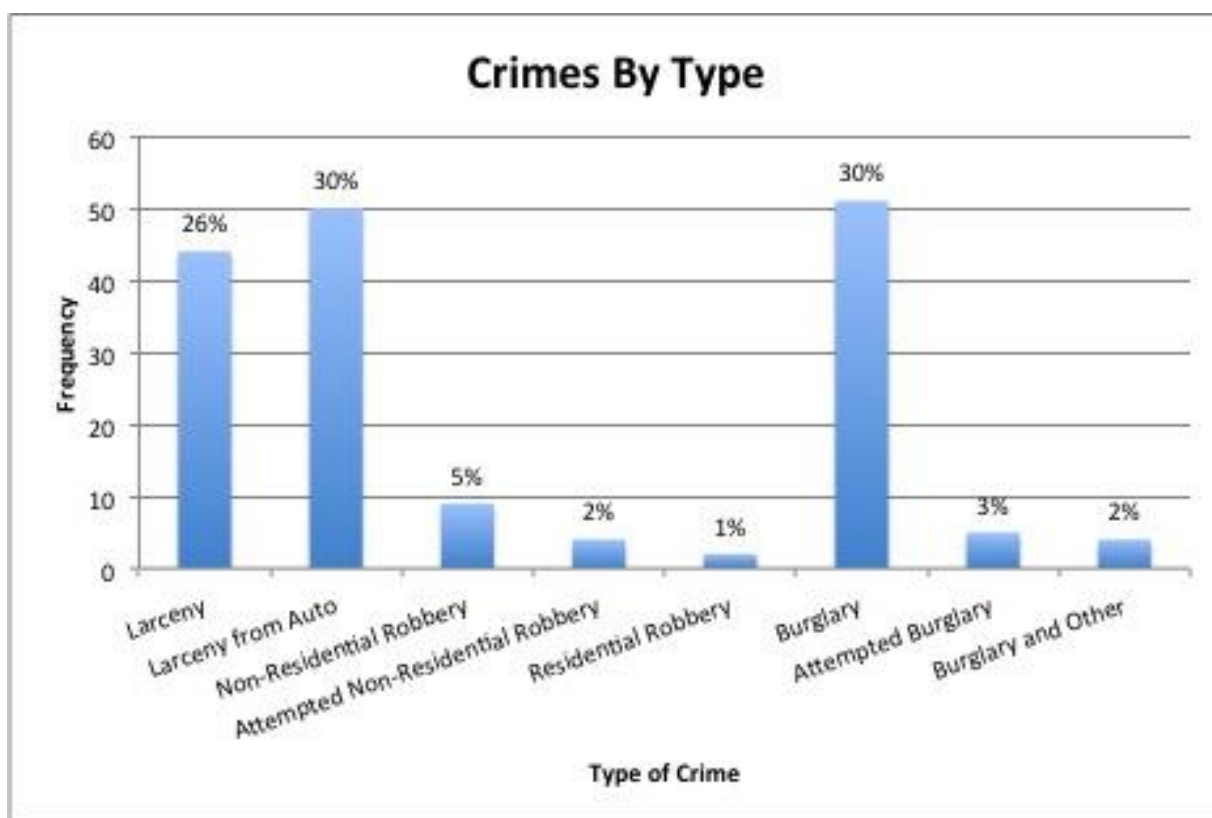

Figure 8: Crimes by type (frequency)

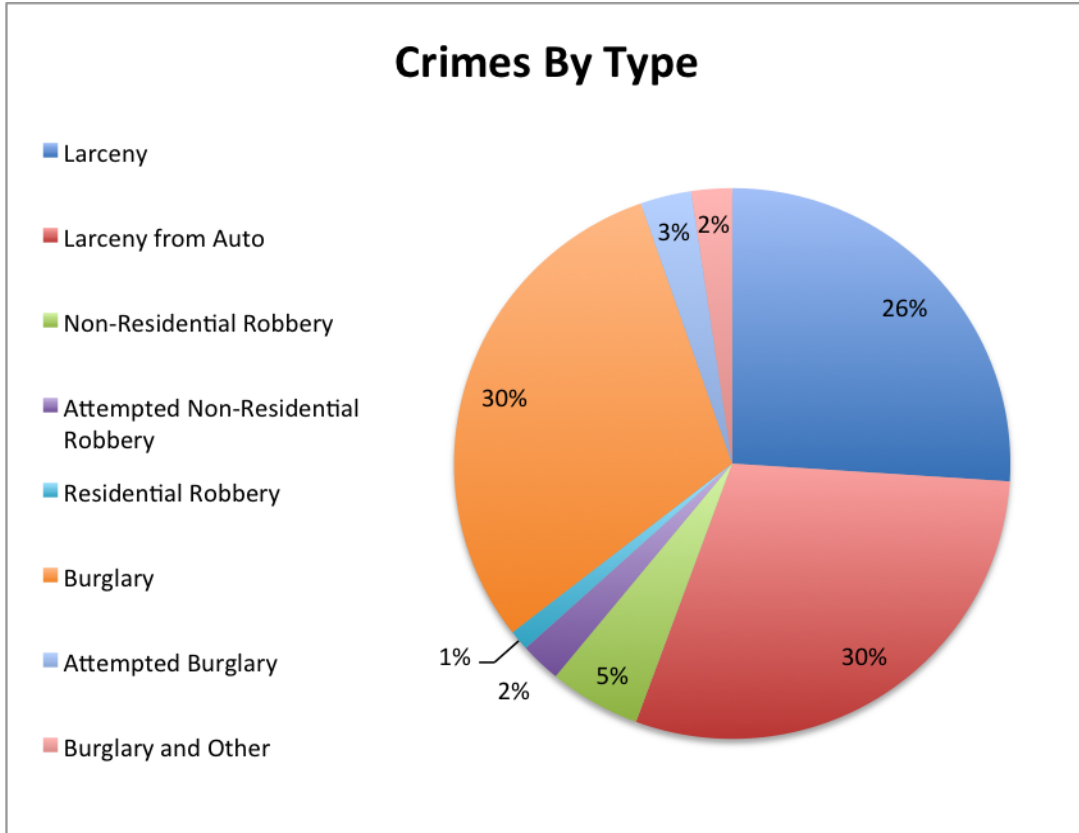

Figure 9: Crimes by type (percentage)

Crime incidents were recurrent on several streets within the neighborhood between January 2008 to December 2010². Knox Road had the highest concentration of larcenies, burglaries, and robberies, with a total of 30 reported crimes. College Avenue, Princeton Avenue, Rhode Island Avenue, Calvert Avenue, and Hopkins Avenue also had relatively high crime frequencies, as indicated in Figure 10.

² The following analyses only include crimes occurring between January 2008 and December 2010; at the time these analyses were conducted, crime reports were not available for crimes that occurred in January and February 2011.

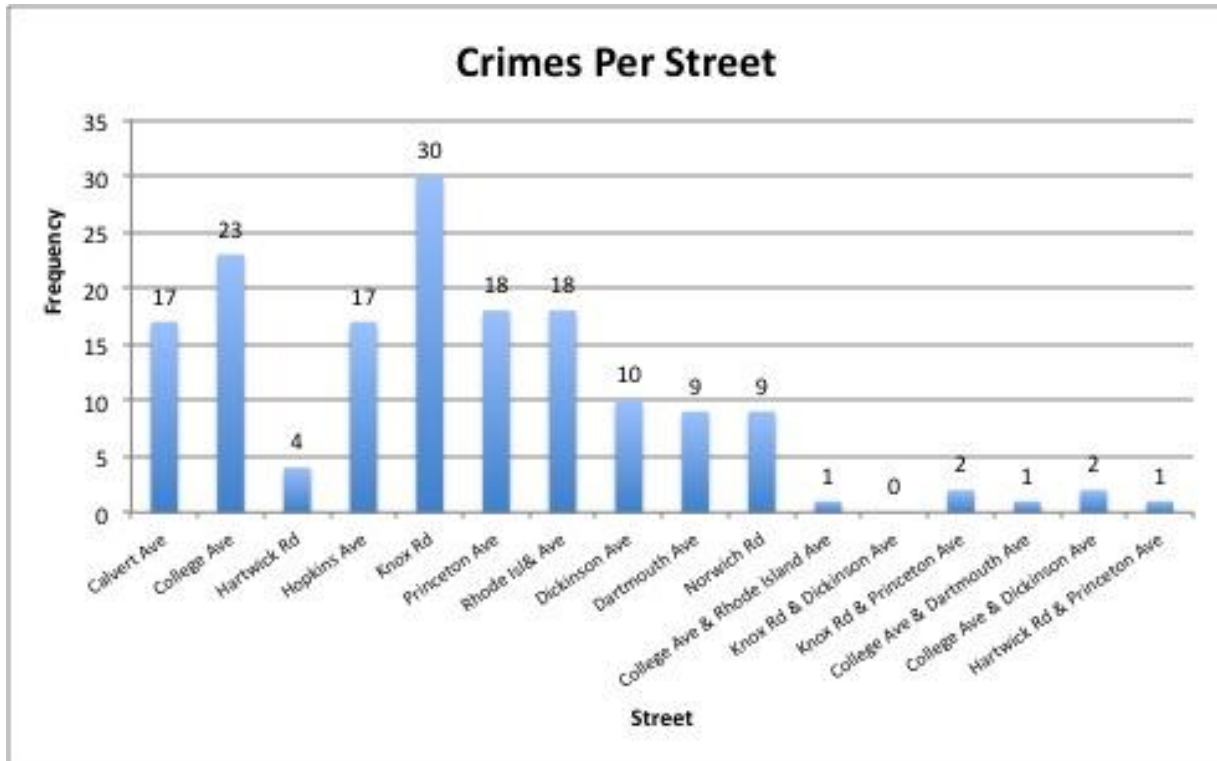

Figure 10: Crimes by location

Information for individual crimes regarding criminal and victim demographics, time committed, reporting lag time, the mode of entry, home and car security (if applicable), as well as other pertinent variables were aggregated and are presented in Table 4.

Table 4: Crime statistics

Number of Criminals	1	2	3	4	5	6	Unknown	Total
Frequency	74	17	5	1	0	1	64	162
Percent (%)	46	10	3	0.5	0	0.5	40	100
Race of Criminals	White	Black	Hispanic	Asian	Mixed	Unknown		Total
Frequency	8	25	2	0	2	125		162
Percent (%)	5	15.5	1.25	0	1.25	77		100
Gender of	Male	Female	Mixed	Unknown				Total

Criminals								
Frequency	37	1	1	123				162
Percent (%)	23	0.5	0.5	76				100
Number of Victims	1	2	3	4	5	Unknown		Total
Frequency	125	27	4	3	2	1		162
Percent (%)	77	17	2	2	1	1		100
Race of Victims	White	Black	Hispanic	Asian	Mixed	Unknown		Total
Frequency	141	9	2	1	1	8		162
Percent (%)	87	6	1	0.5	0.5	5		100
Gender of Victims	Male	Female	Mixed	Unknown				Total
Frequency	106	47	7	2				162
Percent (%)	65.5	29	4.5	1				100
Status	Student	Non-student	Unknown					Total
Frequency	115	29	18					162
Percent (%)	71	18	11					100
Time of Day	Day	Night	Unknown					Total
Frequency	23	58	81					162
Percent (%)	14	36	50					100
Break	Winter	Summer	Spring	Thanksgiving	None			Total
Frequency	28	36	4	1	93			162
Percent (%)	17	22	2.5	1	57.5			100
Reporting Lag Time	≤ 1 hour	≤ 24 hours	≤ 1 week	> 1 week				Total
Frequency	124	21	11	6				162

Percent (%)	76	13	7	4				100
Security	Locked	Unlocked	Not Applicable	Unknown				Total
Frequency	63	41	24	34				162
Percent (%)	39	25	15	21				100
Item Stolen	Inside Home	Outside Home	Inside Car	On Person	Other	None	Unknown	Total
Frequency	75	20	23	10	11	22	1	162
Percent (%)	46	12	14	6	7	14	1	100
Anyone Present	Yes	No	Not Applicable	Unknown				Total
Frequency	53	89	10	10				162
Percent (%)	33	55	6	6				100
Damage	Door	Window	Door and Window	Other	None	Unknown		Total
Frequency	13	30	4	5	107	3		162
Percent (%)	8	19	2	3	66	2		100
Weapons Used	Gun	None	Other	Unknown				Total
Frequency	7	150	1	4				162
Percent (%)	4	93	1	2				100
Victim Injuries	Yes	No						Total
Frequency	10	152						162
Percent (%)	6	94						100

Results concerning criminals reflect a high number of unknowns, indicating that a large proportion of victims did not come into contact with the perpetrator(s) and thus could not report

specific demographic information, which led to the low clearance rate for property crimes. The “Mixed” category refers to crimes in which there were groups of perpetrators or victims comprised of different races and genders.

Out of all the crimes in Old Town College Park, 46% had one suspect in question, and 14% of crimes involved two or more suspects. For cases in which race was known, the racial composition of the suspects was 71% Black, 23% White, and 6% Hispanic. Male suspects accounted for 97% of crimes for which gender was identified.

Among the victims, 77% were single victims, and 23% were victimized with other people. The racial breakdown of the victims was 87% White, 6% Black, and 1% Hispanic. The share of victims who were male was 65.5%. University of Maryland students made up 71% of the victims, which is expected since many students reside in and visit this neighborhood.

Over half of the burglaries, robberies, and larcenies were committed while the University of Maryland was in session; crimes committed during summer and winter breaks when most students were neither living in nor frequenting the area accounted for 22% and 17% of crimes, respectively. Most of the crimes were not strong-arm crimes; gun use occurred in only 4% of crimes, and crimes that led to victim injury represented only 6% of all incidents. The majority of crimes (76%) were reported within an hour of the victim realizing the crime had occurred, while 13% of crimes were reported in less than 24 hours, and only 4% of crimes were reported one week later.

In cases involving homes or vehicles, 46% of the crimes occurred when the house or car was believed to be unlocked, while 30% occurred when the house or car was locked. Sixty-seven percent of any damage was made to a window, followed by the door (24%), and both a door and window (9%). Items were stolen from the inside of a home or car for half of the

crimes, and in 55% of the cases, there were neither bystanders nor the presence of a person nearby.

In summary, these findings reveal that theft from auto and residential breaking and entering occurred more frequently in Old Town College Park, each with a total of 50 incidents from 2008 to 2010. Knox Road and College Avenue both faced relatively high frequencies of crime. As expected, over half of the crimes occurred while school was in session, and students comprised a large proportion of victims. The data shows that among residential crimes and thefts from autos, 46% occurred when houses and vehicles were unlocked, giving criminals easy entry to steal items, yet another 30% of crimes occurred when homes or vehicles were locked. These results lend greater insight on crime in Old Town College Park and have policy implications that will be discussed in Chapter 5.

Survey

Survey Analysis Method

Chapter 3 discusses the similarities between the samples and their respective populations. Subsequent survey analysis compared resident and non-resident responses in order to determine what degrees of similarity, if any, exist between the samples. The survey data was analyzed using Excel. Because two different surveys were given to residents and non-residents, only data from questions appearing in both versions was combined. Aggregate averages for the resident and non-resident samples were calculated by combining the averages for pre- and post-intervention survey results.

After aggregate averages were collected for each sample, a t-score was calculated in order to assess whether the means of the two samples are statistically different from one another.

0.10 was the alpha used for the two-tailed t-test³, thus if a score was 1.64 or greater, there was a significant difference in the means. It is important to note that for non-Likert scale questions, a test of the various proportions of responses was conducted by calculating aggregate averages for each individual answer choice instead of the question as a whole as was done for the Likert scale questions.

The following tables summarize the results from the questions appearing in both the resident and non-resident versions of the survey. T-scores in red indicate a statistically significant difference between the two samples' means ($p = 0.10$ or less). Please note that some t-scores in the "Non-Likert Scale Questions" table may be missing because there were too few cases to make a reasonable assessment.

Table 5: Likert scale questions

Question	Resident			Non-Resident			t-score
	Agg Avg	# Responses	Std Dev	Agg Avg	# Responses	Std Dev	
<i>How safe do you feel in the following situations?</i> Walking alone during the day in this area	4.31	186	0.84	3.93	494	0.85	5.21
<i>How safe do you feel in the following situations?</i> Walking alone at night in this area	2.33	185	1.12	2.10	494	0.99	2.6
How likely do you think you will be a victim of crime?	4.45	191	2.02	4.38	490	1.88	0.43
To what extent are you worried about crime in this area?	2.77	182	0.78	2.70	491	0.67	1.15
In general, how do you feel about security cameras?	6.58	181	2.45	6.85	484	2.25	1.36
<i>To what extent do you agree or disagree with the following statements?</i> Security cameras would help to	3.38	182	1.06	3.47	488	0.89	1.1

³ Due to the exploratory nature of the research, an alpha of 0.10 was deemed appropriate.

deter criminal activity.							
<i>To what extent do you agree or disagree with the following statements?</i> I would feel safer if more security cameras were implemented in this area.	3.32	181	1.07	3.59	488	0.94	3.17
<i>To what extent do you agree or disagree with the following statements?</i> Policing in this area is successful in tackling crime overall	2.53	178	1.07	2.78	485	0.86	3.1
<i>To what extent do you agree or disagree with the following statements?</i> The Prince George's County Police successfully reduces crime and anti-social behavior	2.40	178	0.99	2.73	482	0.88	4.13
<i>To what extent do you agree or disagree with the following statements?</i> The University Police/Police Auxiliary successfully reduces crime and anti-social behavior	2.42	178	0.95	2.69	480	0.90	3.37
<i>To what extent do you agree or disagree with the following statements?</i> This area is a safe place to be.	2.80	178	1.02	2.42	485	0.85	4.84
How worried are you about being a victim of the following? Auto theft	2.35	177	1.13	2.43	477	1.19	0.77
How worried are you about being a victim of the following? Disturbances caused by people in the area	2.66	176	1.09	3.11	476	1.01	4.94
<i>How worried are you about being a victim of the following?</i> Harassment because of race and/or ethnic background	2.02	175	1.05	2.22	478	1.02	2.2
<i>How worried are you about being a victim of the following?</i> Illegal drug use and/or dealing drugs	2.38	176	1.12	2.48	478	1.15	0.99
<i>How worried are you about being a victim of the following?</i> Physical assaults (including sexual assaults)	3.30	176	1.16	3.56	479	1.13	2.59
<i>How worried are you about being</i>	3.68	176	1.09	3.86	475	1.0	1.94

<i>a victim of the following? Street robbery or muggings</i>						4	
<i>How worried are you about being a victim of the following?</i>						1.2	
Vandalism to or theft from auto	2.81	175	1.26	2.96	478	8	1.33
How afraid are you of being a victim of crime?	5.34	191	2.15	5.29	472	1	0.27
<i>If reported: Please rate your satisfaction with the response you received after reporting the crime.</i>						1.1	
Courtesy of the police	3.01	70	1.37	3.17	77	3	0.78
<i>If reported: Please rate your satisfaction with the response you received after reporting the crime.</i>						1.0	
Speed of response	3.11	71	1.19	3.18	77	5	0.38
<i>If reported: Please rate your satisfaction with the response you received after reporting the crime.</i>						0.9	
Knowledge of the local area and local issues	3.19	70	1.02	3.47	75	1	1.74
<i>If reported: Please rate your satisfaction with the response you received after reporting the crime.</i>						1.1	
Effectiveness of response	2.79	70	1.15	3.14	79	1	1.9
<i>If reported: Please rate your satisfaction with the response you received after reporting the crime.</i>						1.1	
The follow-up information and support you received	2.61	69	1.13	2.76	75	3	0.8

Table 6: Non-Likert scale questions

Question	Resident		Non-Resident		t-score
	AggAvg	# Responses	AggAvg	# Responses	
<i>At which of the following times of day do you think the most crime in the area takes place?</i>					
Early hours (2am-6am)	55.35%	107	52.85%	247	0.23
Early morning (6am-9am)	1.30%	2	0.60%	3	-
Morning (9am-12pm)	0.00%	0	0.00%	0	-
Afternoon (12pm-5pm)	0.00%	0	1.35%	7	-

Early evening (5pm-8pm)	1.10%	2	0.90%	5	-
Late evening/night(8pm-11pm)	2.55%	4	5.80%	32	-
The midnight hours (11pm-2am)	39.70%	73	38.45%	200	0.16
<i>If you are worried about being a victim of crime, what are some of your reasons for feeling this way? (Check all that apply.)</i>					
I have experienced it before	14.86%	26	4.80%	26	0.76
I know someone who has experienced it before	61.56%	111	33.22%	161	4.60
I have heard stories of it happening to other people	82.14%	150	71.86%	350	2.25
I have read articles in the Diamondback newspaper that describe crimes that have occurred in my neighborhood block (in College Park)	75.07%	137	71.11%	345	0.77
I have read crime alerts sent by the University of Maryland Police Department that describe crimes that have occurred in my neighborhood block	82.63%	150	84.69%	412	0.45
Specific individuals in this area worry me	17.18%	32	8.05%	38	0.80
This area has a bad reputation for crime	64.55%	117	62.28%	301	0.46
None, I am not worried about being a victim of crime	5.04%	9	9.10%	45	-
<i>What do you think are the causes of crime in this area? (Check all that apply.)</i>					
Alcohol related reasons	67.03%	120	66.37%	319	0.08
Drug related reasons	55.35%	98	49.54%	246	0.70
Not enough police presence	38.20%	69	40.75%	198	0.30
Easy access to property	62.45%	112	54.13%	268	1.32
Unemployment	27.24%	49	33.49%	166	0.62
Low incomes	52.17%	94	54.29%	272	0.38

Professional criminals	23.34%	43	17.61%	85	0.44
Lack of community cooperation	24.92%	43	24.68%	124	0.20
The other tenants do not take crime prevention seriously	16.91%	29	17.56%	89	0.16
<i>Are there any security cameras in this area?(Yes or No)</i>	35.80%	65	20.85%	93	1.93
<i>Which of the following are present in this area? (Check all that apply.)</i>					
Emergency telephones	57.58%	100	44.94%	205	2.01
External lighting	85.05%	148	79.33%	357	1.43
Maintenance of building (ie. buildings are properly maintained)	61.21%	107	39.01%	176	3.42
Maintenance of landscape (trimming bushes, planting flowers, etc)	63.84%	111	36.24%	163	4.43
Police patrol in the community	59.79%	101	45.20%	211	2.36
Sidewalks	88.22%	152	88.90%	406	0.19
Security cameras	42.15%	73	22.93%	99	2.49
<i>Please answer "Yes" or "No" to the following questions. Do you generally avoid going out after dark?</i>	24.98%	176	30.65%	480	1.40
<i>Please answer "Yes" or "No" to the following questions. Do you avoid groups of people on the street?</i>	48.41%	175	59.08%	479	2.42
<i>Please answer "Yes" or "No" to the following questions. Do you avoid using public transport alone after dark?</i>	36.71%	176	39.41%	478	0.38
<i>Please answer "Yes" or "No" to the following questions. Do you avoid going out alone?</i>	62.21%	176	70.73%	478	2.10
<i>Which of the following crimes have you personally</i>					

<i>experienced in the last 12 months?</i>					
Auto theft	0.00%	0	1.01%	5	
Disturbances caused by neighbors	27.50%	45	12.81%	59	1.64
Harassment because of race and/or ethnic background	4.90%	8	5.00%	22	-
Illegal drug use and/or dealing drugs	16.60%	25	7.43%	34	0.82
Physical assaults (including sexual assaults)	8.25%	13	3.67%	16	-
Residential burglary	9.60%	18	2.63%	13	-
Street robbery or muggings	3.40%	5	1.47%	7	-
Theft from grounds or shed/garage	5.65%	9	3.21%	14	-
Vandalism to or theft from auto	13.75%	21	5.87%	29	0.63
Vandalism, graffiti, or damage to property (other than auto)	3.60%	6	3.60%	17	-
None of the above	51.05%	81	68.80%	316	2.72
Did you report the crimes that you experienced (if any) to the police or any other agency?					
Yes	22.10%	40	8.75%	45	1.36
No	23.20%	43	20.25%	96	0.18
N/A	52.40%	90	69.45%	333	2.89
<i>If reported: Who did you report this crime to? (Check all that apply.)</i>					
Landlord	3.30%	15	2.40%	9	-
University of Maryland Police	3.20%	14	8.10%	29	-
Prince George's County Police	14.30%	30	7.10%	26	0.41
Neighborhood Watch	0.00%	0	0.30%	2	-
N/A	71.85%	120	86.80%	389	3.71
<i>If NOT reported: Which of the following factors, if any, caused you to not report the crime? (Check all that apply.)</i>					
I did not think it was serious enough	19.17%	31	18.69%	81	0.08

I could not be bothered to report it	8.68%	13	3.05%	15	-
Someone else reported it	4.20%	7	2.40%	11	-
The police would not be able to do anything	14.96%	24	11.19%	46	0.01
The police would not take the crime seriously/would not be interested	15.76%	25	8.94%	36	-
The police were too busy	1.84%	3	1.40%	5	-
I was able to sort the problem out myself	3.96%	6	4.50%	18	-
It was unlikely that the criminal(s) would get caught	9.96%	16	11.29%	49	0.36
I was scared of revenge attacks/reprisals	1.84%	3	2.80%	9	-
N/A	67.71%	107	74.26%	332	0.71

Survey Descriptive Statistics

As can be seen from the tables above, the results show some statistically significant differences, generally with the resident sample responding with a significantly greater frequency for an attribute than the non-resident sample. First, according to the data, there is a statistically significant difference between the two samples' perceptions of safety. When asked how safe they feel walking alone in the dark or during the day, residents appeared to feel safer than non-residents in both situations. The non-residents tended to feel less safe walking in the target area and even tended to avoid groups of people on the street while walking more than residents did. Overall, a higher frequency of residents agreed that the target area is a safe place to be. These outcomes may be due in part to the residents' familiarization with the area.

Although residents tend to feel safer than non-residents while walking around in the area, a statistically significantly larger proportion of non-residents than residents stated that they would actually feel safer if cameras were implemented in the target area. Interestingly 72% of non-residents surveyed were not sure if there were already cameras in the target area, compared

to just 39.4% of residents. It may be that non-residents believe that the implementation of cameras will reduce the level of crime because they do not think that cameras are currently in place, whereas residents are not as enthusiastic about the effectiveness of cameras in reducing crime because they may already know or believe they exist in the target area. It appears that residents are more aware of the presence of crime prevention techniques such as emergency telephones, cameras, policing, and the maintenance of the landscape.

However, although residents appear to be more aware of crime prevention methods present in the target area than non-residents, non-residents tend to have more confidence in the effectiveness of crime prevention strategies and tactics than do residents. For instance, when asked if policing, specifically that of the Prince George's County Police or the University of Maryland Police Auxiliaries, is successful in reducing crime and anti-social behavior, non-residents tended to agree more than residents. In addition, non-residents seemed to be more satisfied with the responses that they received from authorities. The results show that there is a statistical difference between the non-residents and residents' perception of the effectiveness and knowledge of the authorities' response to their reported crimes.

In conjunction with feeling less safe in the target area, the non-residents also exhibited a higher frequency of the fear of victimization. There is a statistically significantly higher frequency of non-residents who worry about being a victim of disturbances caused by other people in the area, harassment because of race or ethnic background, physical/sexual assaults, and street robbery or mugging. This is notable because although a higher proportion of non-residents reported fearing these crimes, a higher proportion of them also reported not being a victim of crime in this area at all, or ever.

In general, non-residents appear to feel less safe in the target area and exhibit a higher fear of victimization than do residents. Residents, however, tend to be more aware of the crime prevention techniques implemented in the area, but are less confident in their effectiveness. Overall, the data shows that the two sample populations are generally similar in their perceptions about personal safety and crime in the target area. However, there still exist some statistically significant differences between these perceptions and these have been discussed in the analysis above.

CPTED

For each property, scores on each item of the CPTED scale were averaged to produce an overall CPTED score. Since two rounds of evaluations were conducted, each property was given two different scores, one from March/April 2010 and the other from September 2010. These two scores were then averaged to produce a final overall score. The maximum value of this score was 1, indicating a property contained every CPTED vulnerability measured, and the minimum value was 0, indicating a property did not contain any observed vulnerabilities. The most vulnerable property in the sample received a final score of 0.50, and the least vulnerable received a score of 0.075. Given this range, the properties were sorted into three groups by score based on natural breaks in the data. These groups indicated a “high,” “middle,” or “low” CPTED score (see Table 7). However, the highest score achieved by a property in the “high” category was only a 0.50. The limited range of CPTED scores, which will be expanded upon later in the text, limited the ability to test the effect of CPTED on crime.

Table 7: The three groups of CPTED vulnerability.

Group	Score	Number of Properties
Low	0 - 0.199	60
Middle	0.2 - 0.299	65
High	0.3 - 0.5	30

To assess the distribution of CPTED scores around the neighborhood, a map of Old Town College Park showing property boundaries was created in Adobe Photoshop. Each property was colored according to its CPTED vulnerability group, with the lightest shade of pink denoting a low CPTED score and red denoting a high score (see Figure 11). The distribution of CPTED vulnerability in the neighborhood appears random, with no obvious clustering.



Figure 11: Distribution of CPTED vulnerability in Old Town, College Park. The figure also shows the location of CCTV cameras placed during the intervention.

Hypothesis 1

Monthly crime frequencies and rates were calculated using the collected crime data (burglaries, larcenies, and robberies) to test the hypothesis that the crime rate in Old Town College Park will reduce after the implementation of cameras (see Table 8). As highlighted in Figure 12, the average monthly crime count for Old Town College Park from January 2008 to February 2011 ranged between two to eight crimes, with January 2010 as an exception. The

figure shows that the variations in monthly crimes were minor and that the crime rate over the three years observed was fairly stable.

Table 8: Monthly crime counts and rates

Month	Number of Crimes	Rate (Per 1000 Residents)
2008		
January	5	8.18
February	3	4.91
March	4	6.55
April	2	3.27
May	4	6.55
June	2	3.27
July	3	4.91
August	5	8.18
September	4	6.55
October	6	9.82
November	7	11.46
December	4	6.55
2009		
January	6	9.82
February	4	6.55
March	8	13.09
April	4	6.55
May	3	4.91
June	2	3.27
July	7	11.46
August	3	4.91
September	6	9.82
October	3	4.91
November	1	1.64
December	2	3.27
2010		
January	17	27.82
February	2	3.27
March	7	11.46
April	3	4.91

May	6	9.82
June	3	4.91
July	3	4.91
August	4	6.55
September	8	13.09
October	4	6.55
November	4	6.55
December	3	4.91
2011		
January	3	4.91
February	4	6.55

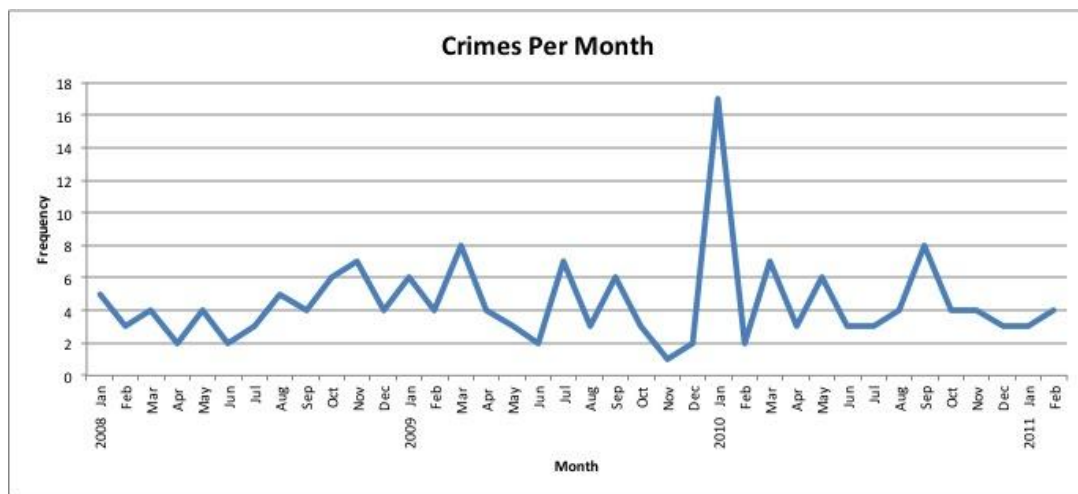

Figure 12: Monthly crime counts from January 2008 to February 2011

Time Period	Average Count	Rate (Per 1000 Residents)
Jan08 - Oct10	4.56	7.46
Nov09 - Feb10 ⁴	1.67	2.73
Nov10 - Feb11 ⁵	3.67	6.00

Table 9: Average crime count and rate pre-intervention and post-intervention

⁴ Excludes January 2010.

⁵ Excludes January 2011.

T-test	T-score	df	Critical Value
(Jan08 - Oct10) vs (Nov10 – Feb11) ⁶	0.53	35	1.69
(Nov09 - Dec09) vs (Nov10 – Feb11) ⁷	-4.22	4	2.13

Table 10: Tests of significance for crimes ($\alpha = 0.05$)

To further test the hypothesis, average crime counts and rates were calculated for the pre-intervention period and the post-intervention period. Data for the month of January was removed from the analysis because January 2010 was a major outlier. When comparing the entire pre-intervention period (January 2008 to October 2010) with the shorter post-intervention period (November 2010 to February 2011), there was a decrease in crime. However, when studying the two periods on a more comparable time scale such that the post-intervention period is analyzed against November through February from the year before, the crime rate was actually higher in the post-intervention period. Formal testing of these comparisons at a 5% significance level shows that the differences in crime levels are not statistically significant⁸, thus indicating that the crime rate did not decrease after camera implementation (see Table 10). The post-intervention period, however, did experience a significantly higher crime count than the same period of months a year before.

These findings signal the need to extend the analysis of post-intervention crimes to ensure more comparable time intervals. This limitation is attributed to the major delay in the

⁶ Excludes January 2010 and 2011.

⁷ Excludes January 2011.

⁸ A small sample size (N) may have contributed to this effect.

installation of the cameras, which presented the researchers with limited time to collect post-camera crime data. A more detailed discussion of this limitation can be found in Chapter 5.

Hypothesis 2

In order to test the second hypothesis that students' perceptions of crime would reflect a greater sense of safety following the implementation of security cameras in Old Town, a series of t-tests ($\alpha = 0.10$; significant when $|t| \geq 1.29$) were run on the data from the pre-intervention and post-intervention survey responses of both residents and non-residents. As shown in Table 11, three particular survey items were selected in relation to this hypothesis, as well as one additional item for residents only. In general, the trend between surveys indicates that both residents and non-residents felt a greater fear of crime in the post-intervention survey than in the pre-intervention survey, although this change occurred at different rates between the two groups.

Question		RESIDENTS		NON-RESIDENTS	
		Mean	t-score	Mean	t-score
How afraid are you of being a victim of crime? [1 = Not afraid at all, 10 = Very afraid]	pre	5.20	-0.73	5.17	-1.75*
	post	5.43		5.53	
How likely do you think you will be a victim of crime? [1 = Not likely at all, 10 = Very likely]	pre	4.62	0.61	4.17	-3.48*
	post	4.32		4.8	
To what extent are you worried about crime in this neighborhood? [1 = Not at all worried, 4 = Very worried]	pre	2.73	-0.58	2.63	-3.11*
	post	2.79		2.83	
Would you say you feel less safe or safer in your neighborhood than you did 12 months ago? [1=Much less safe, 5=Much safer]	pre	2.88	-1.49*	---	---
	post	2.65		---	

Table 11: Tests of significance for survey responses
Note. * $\alpha = 0.10$, significant when $|t| \geq 1.29$

The first item of interest, “How afraid are you of being a victim of crime?” was rated on a scale of 1 to 10, with 1 signifying “Not afraid at all” and 10 signifying “Very afraid.” Statistical analysis on this survey item indicated a significant difference between pre-intervention and post-intervention responses among non-residents ($t = -1.75$). The second item, “How likely do you think you will be a victim of crime?” which was rated from 1 to 10 (1 = “Not likely at all”; 10 = “Very likely”), also yielded a significant difference between pre-intervention and post-intervention response means for non-residents ($t = -3.48$). The third item of interest, “To what extent are you worried about crime in this neighborhood?” was rated using the following scale: 1 = “Not at all worried,” 2 = “Not very worried,” 3 = “Fairly worried,” 4 = “Very worried.” Again, a significant difference was found between the pre-intervention and post-intervention responses of non-residents ($t = -3.11$). The t-tests conducted on resident responses to these same three survey items did not yield any significant results.

These findings indicate a change in the perceptions of crime in Old Town College Park among non-residents but not among residents. For all three survey items, these changes in non-resident perceptions were found to run contrary to the direction of the hypothesis, instead indicating that non-residents perceived a *lower* sense of safety following the implementation of security cameras. Specifically, post-intervention survey responses indicated that non-residents worried more about crime, were more fearful of being a victim, and thought they were more likely to be victimized.

The only significant change found between resident perceptions in the pre-intervention and post-intervention surveys was also in the negative direction. Resident responses to the question “Would you say you feel less safe or safer in your neighborhood than you did 12 months ago?” (rated from 1 to 5; 1 = “Much less safe,” 5 = “Much safer”) were found to be

significantly lower in the post-intervention survey than the pre-intervention survey ($t = -1.49$). Contrary to the hypothesis, residents were more likely to report feeling less safe than they did a year before when responding to the post-intervention survey than when responding to the pre-intervention survey.

To determine whether residents' awareness of cameras had changed between the pre- and post-intervention surveys, responses to the question "Are there any security cameras within a 100-meter radius of your building?" were tested for significance. The z-scores for each of the three possible responses to this question were -0.07 for "Yes," 0.07 for "No," and 0.74 for "I don't know." None of these z-scores indicated a significant difference between the pre- and post-intervention survey. These results suggest that residents' awareness of the cameras did not increase after their implementation, as can also be seen through the comparable percentages of respondents who answered "Yes" to this question (35.5% in the pre-intervention survey and 36.1% in the post-intervention). This finding may explain the lack of improvement in perceived safety among residents, as further discussed in Chapter 5.

Besides the lack of support for Hypothesis 2, the results of these statistical analyses interestingly suggest a greater amount of significant perception changes from non-residents than residents. The high frequency of serious crimes committed in the College Park area during the fall of 2010 (see Appendix F) may account for this greater change in non-resident crime perceptions. Since the post-intervention survey distribution coincided with this period of higher crime, the prominence of these crimes could have generated in students a more negative perception of crime in general, which may have then translated into more negative views of safety in Old Town College Park as reflected by the non-resident responses.

Regardless of these differences between residents and non-residents, it appears that students in general felt slightly more fear of crime following the implementation of CCTV cameras in the Old Town area. Potential reasons for this increase are discussed in Chapter 5.

Hypothesis 3

It was hypothesized that high CPTED vulnerability of a property would be correlated with an increased likelihood of crime occurring at that property. To test this theory, data collected for burglaries, larcenies, and robberies committed in Old Town from January 2008 to December 2010 was compared with the CPTED scores of the neighborhood properties. Since the odds of any single property experiencing a crime were very low (only 62 properties reported relevant crime incidents during the data collection period), crime rates were compared to the high, medium, and low CPTED groups rather than to individual properties (see Table 7). The point estimate (PE) indicates the proportion of each CPTED score group at which at least one crime was reported. A 95% confidence interval (CI) was calculated for each group, to account for the sample size of each group.

Chapter 5: Discussion

Summary

This research sought to examine the relationship between crime rates in an off-campus college community, the perceptions of crime of the residents and non-residents of that area, and the CPTED vulnerabilities of the area before and after a CCTV camera intervention. Although crime rates in College Park are decreasing, fear of crime remains high. Moreover, the crime rate off campus continues to be a problem. Through crime mapping and spatial analysis techniques, the researchers were able to identify an off-campus, student-occupied residential area with relatively high rates of larcenies, burglaries, and robberies. Once the area was identified, the researchers were able to collect both quantitative and qualitative data about crime, perception of crime, and existing environmental design of the neighborhood's properties. These data were used to identify trends in how crime and perception of crime changed in response to the installation of CCTV cameras.

The research was broken down into three parts: assessing CPTED vulnerabilities, determining residents' and non-residents' perceptions of crime, and evaluating crime data in the given area. In order to assess the CPTED vulnerabilities of the area, the researchers produced a scale, which examined aspects such as lighting, yard maintenance, and territoriality. The researchers then performed a series of site assessments and evaluations, both during the night and day, to assess the neighborhood as a whole, as well as each individual property. After analyzing the data, no geographical pattern was observed in the distribution of CPTED vulnerability, and no relationship between CPTED vulnerabilities and crime rates was detected; these results may be attributed to the homogenous nature of the residential properties.

Next, the researchers used two different surveys, one for residents and one for non-residents of the area, to determine the perceptions of crime. The researchers used convenience sampling in order to recruit survey participants through methods such as Facebook, listservs, flyers, and door-to-door canvassing. The survey was distributed both before and after the implementation of CCTV cameras to evaluate the change in perceptions of crime and the effect the cameras had on these changes. Statistical analyses of the survey data determined that there was a change in crime perceptions. However, these changes show that residents and non-residents actually perceived a lower sense of safety following the implementation of the cameras.

Finally, in conjunction with the Prince George's County Police Department, the researchers were able to access records of off-campus crimes (burglaries, larcenies, and robberies) committed in Old Town College Park starting from January 2008 to February 2011. The crime reports were coded for important details such as location, criminal and victim characteristics, and time of incident. Because the researchers were not able to collect a sufficient amount of crime data post-intervention, the results from the analyses were mixed and therefore no clear conclusions could be drawn on the efficacy of the cameras as a crime deterrent in the area.

Implications

This research study focused on higher rates of crime victimization off campus at the University of Maryland. Indeed, as determined by local reports and general trends at higher educational institutions, on-campus areas usually feature lower crime rates. The crime data collected throughout the course of this study demonstrated that the rate of crime victimization was indeed higher off campus than on campus at the University of Maryland. Moreover, the

analyses made on the crime data collected over the course of the study, including the camera installation intervention, suggested that there were no significant changes in crime after the camera intervention. However, because of a lack of time to study crime following the intervention, these results are only suggestive and an extension of this study post-intervention is required.

This research did, however, uncover discrepancies between non-residents and residents of the studied area concerning crime perception and perception of the cameras. Residents were found less likely to expect to be safer if more cameras were implemented in the area compared to their non-resident counterparts. This corroborates the apparent worsening of perception that occurred following the implementation of the camera intervention, especially in the non-resident population. Moreover, residents were found to be significantly more aware of CPTED measures in place, such as cameras or blue-light phones, as well as police frequenting the area, than non-residents. There appears to be a link between familiarity with an area and the perception of crime in that area. Non-residents may not be aware of camera installation and instead base their perceptions off of media coverage, which may be negative. This suggests that in large college communities, off campus camera installation may be viewed negatively by the on-campus community in terms of safety despite camera's abilities to deter crime. Therefore, cameras may not be a good policy decision for this population, based solely on perception. Because short-term perception is a narrow qualification, further research would be required to elucidate effect on perceptions, as well as crime rates.

This study was novel because cameras had never before been evaluated against crime rates and crime perceptions in a college's off-campus, privately rented student-occupied neighborhood. According to the literature, it was expected that the installation of CCTV cameras

would initially ameliorate perception of crime, while positive perceptions could deteriorate over time as people became less aware of the cameras. However, in some residential areas, initial camera installation can actually cause fear of crime to increase (Gill, Bryan, & Allen, 2007). Indeed, in this research, the residents of the target area were found to be more fearful of crime following the implementation of the CCTV camera intervention. Although cameras help to promote safety in an area, they may also increase people's awareness of crime in that area, initially resulting in heightened fear of crime. Meanwhile, following the intervention non-residents felt more afraid of being a victim, thought that they were more likely to become a victim, and became more worried about crime in the target area.

These perceptions of crime may have also been affected by the publicity of the cameras in local media, in addition to high-profile crimes that occurred throughout the course of this study (see Appendix F). Although overall crime rates may have dropped, reports of multiple stabbings or muggings could have easily led to an increase in perceived risk. Over time, if crime rates are reduced in such a way that these high profile crimes are less likely to occur, these perceptions may improve. During the fall of 2010, the Prince George's County Police Department made numerous efforts to enhance its public perception and relationship with students. This is especially important as there were several high-profile crimes during this time period, as previously discussed. The Department hosted a number of student-targeted campaigns, including a carnival-themed fair with various activities, informative safety demonstrations, and prizes. Police officers staffed the event in the parking lot of the City Hall on Baltimore Avenue, and it was held at the beginning of the semester to reinforce safety issues with students.

According to Major Robert Liberati, the Prince George's County Police Department also increased its police force monitoring the streets of College Park, particularly during the night and

early morning. These guardianship efforts may have complemented the effect of the cameras, and affected student perceptions of crime during the post-intervention survey phase. Liberati also added that the Prince George's County Police Department increased the amount of crime alerts sent to the university community to establish a more permanent relationship with students. Crime alerts are integral to student perceptions of crime, especially in the face of sensationalized reporting in the Diamondback and other media outlets. Police also sent out reports of crimes that were eventually solved; while these reports may have reminded students of a crime they otherwise had already forgotten, police believe that students' feelings of safety would increase knowing that a crime had been solved.

This study did not attempt to address the benefits of a camera intervention beyond crime prevention. However, cameras play a significant role in crime investigation and resolution. As cameras are used to catch criminals, the perception of the efficacy of and safety provided by cameras may also improve, especially if effectively publicized. Because of the limited time following camera implementation in this study, longer-term conclusions could not be drawn. However, as previously mentioned, this research provides an initial glance at use of cameras at a large public university in the US, where negative perception of cameras suggested it may be a dubious policy decision for these off-campus areas.

This research also contributed to the field of criminology in a more basic sense, as the survey instruments used targeted an original subject. The surveys used were synthesized from disparate surveys that measured many different aspects of fear of crime and perception of crime. Moreover, this research also analyzed a CCTV camera intervention at a university in the United States to assess its effect on both perception of crime and levels of crime in that area. Such a study may help elucidate the relationship between crime levels affected by cameras in relation to

perception of crime in an area, although this study was unable to effectively link and co-analyze these disparate aspects.

This research also explored novel approaches in the field of CPTED. Although there is a great deal of research and municipal police department work on assessing housing according to CPTED vulnerabilities, this study took a different approach by creating a holistic scale based off of CPTED principles. Instead of pointing out vulnerabilities and presenting these results as a basis for an intervention, this study's scale strove to be basic and easily reproducible, giving each property a general crime vulnerability score based on a variety of CPTED criteria. Although no weighting of the criteria was used because of the inability to quantitatively cross-analyze the efficacy of one CPTED approach to another, the scale's purpose was to broadly evaluate properties, then see if these criteria were in any way linked to crime occurring at these properties. This direct link between comprehensive CPTED vulnerabilities and crime rates was in itself novel, even though the results proved inconclusive. Any differences in crime rates across properties were difficult to distinguish in the area because of the homogeneity of the properties; properties in the area did not feature many great differences between CPTED scores. This means that even if there were differences in crime rates between properties, no spatial patterns arose from analysis. Further suggestions to address these limitations will be expressed in later discussion.

Finally, from a community standpoint, this project's approach was novel, not only in terms of analyzing privately-rented, student-occupied, off-campus housing in the United States, but also in terms of incorporating community involvement. The researchers established a mutually beneficial relationship with the Prince George's County Police Department and also

worked extensively alongside the City of College Park and the University of Maryland Police Department in order to complete the intervention and fully analyze the results.

Limitations

Crime Data

Given that the process of coding crime data required multiple steps and participation from different actors, it is possible that along the way it was not effectively executed. All possible measures, including double-checking the data and delegating the coding role to only two researchers, were taken to ensure validity, consistency, and accuracy, but there remained room for error. It is possible that, of the crimes that were selected for consideration, not all of the reports were available or accessible at the police station, which the researchers did not have the jurisdiction to control.

The fact that the study focused solely on burglaries, robberies, and larcenies is an inherent limitation in the perception data. Participants may have less experience with robbery or burglary as they do with assault or another type of crime; or they may have a general fear of crime with little differentiation in their minds as to what type or types of crimes causes them the greatest fear. The target area is also an inherent limitation to the measurability of perception and fear of crime; students may harbor a general fear of crime that is not relative to a specific area. As a result, the perception data may be skewed since the survey asks students to answer the questions based solely from their experience in the particular target area.

Survey

It is possible that there was volunteer bias in those who ultimately chose to participate. If a student was particularly concerned about crime and partook in the study solely because of this

reason, his or her participation and answers might differ from an individual that was not particularly concerned with crime.

The nature of convenience sampling may have biased the sample towards participants in similar academic and social networks as those of the researchers. Some traits of the researchers and the sample population include, but are not limited to: membership in the Class of 2011, membership in the Gemstone program and Honors College, and other academic and extracurricular groups. These characteristics are not solely representative of the student body of the University of Maryland, thus a variety of solicitations through campus listservs, flyers in all academic buildings and dormitories, and Facebook invitations were utilized to attempt to reach a range of students at the University.

Since the study is subject to turnover inherent to a college campus, including student housing, perception data may have been affected by this natural ebb and flow. Students may feel a lack of attachment or investment in an area if they do not live in the same space for an extended period of time; this may ultimately affect their behaviors and the precautions they take against crime. Given that surveys were distributed during the fall semesters, the residents may not be familiar with the area in terms of crime, simply because they have not been living in the area for an extended period of time. Thus, of those surveyed who were new residents, (respondents were asked to specify how long they had been living at their place of residence) there may have been an inherent “ignorance” to the crime levels and vulnerabilities in their neighborhood, which would in turn affect perceptions and survey responses.

Installation of CCTV Cameras

The installation of the CCTV cameras was both a key aspect of the study and one over which the researchers had little control. The City of College Park received a grant in July 2009

for the installation of 19 CCTV cameras in Old Town College Park. The cameras were originally set to be installed and activated no later than June 30, 2010, as stipulated by the grant period. However, there were numerous bureaucratic and logistical hurdles, including but not limited to: zoning regulations, installation permits, PEPCO and Avrio regulations, and other similar complications. The cameras were ultimately installed and made operational, with some inconsistencies in performance, at the end of October 2010. This allotted the researchers only four months to conduct and analyze both crime data and perception data in measuring the effect of the camera intervention, assuming that residents and non-residents were even aware that cameras had been installed.

In terms of crime data, four months was not sufficient time to discern a change in crime levels, in comparison to the pre-intervention period of twenty-two months. For the perception survey, this short time span may not have given Old Town residents ample time to notice and adjust to the presence of CCTV cameras in their neighborhood, as reflected by the generally unchanged pre- and post-intervention survey responses regarding their awareness of cameras in the area. It is possible that residents' perceptions of safety would have improved if they had been more conscious of the camera implementation. However, the researchers had absolutely no control over the progress and ultimate installation of the CCTV cameras.

CPTED Scale

When designing and applying the CPTED portion of the research, various limitations occurred concerning the CPTED evaluations and the CPTED scale itself. The majority of the conceptual limitations occurred during the site evaluations because of procedures and conditions that were beyond the research team's control. Because it was not feasible to gain access to individual properties, it was impossible to test certain key factors, such as doors being locked.

Furthermore, the researchers were not able to access the backyards of any of the homes in the target area, and, therefore, the backyard had to be eliminated as a factor in determining the CPTED score. Another conceptual limitation faced by the researchers was the obstruction of sightlines by trees and bushes, making it difficult to see certain parts of certain properties. As a result of inconsistency in blocked sightlines, certain criteria such as “trash is present” and “yard is unkempt” were simply not visible to the researchers and could not be marked. Because of these limitations, some houses scored better on the CPTED scale simply because certain CPTED vulnerabilities could not be tested or seen.

Next, the researchers were unable to measure camera surveillance accurately, as camera range was qualitatively evaluated, which may have introduced inconsistencies into the assessment. For example, the researchers estimated if the camera could accurately view a certain property and if it was within sight distance. There was no strict principle to evaluate camera range, since the researchers did not know the cameras’ specifications at the beginning of the study. Therefore, the criteria “no visible cameras” was also marked for properties the researchers felt were out of range of a nearby camera.

The final issue concerning the CPTED evaluations was due to the time constraints of the research and that of the individual researchers. The sheer number of properties in the area of interest made it impossible to evaluate each property on the same day, and due to scheduling difficulties, evaluations were spread out over weeks at a time. As a result, properties were not evaluated at the exact same time and were often evaluated on different dates, introducing potential inconsistencies due to short-term maintenance changes in the neighborhood. Similarly, the CPTED evaluations, especially those conducted at night, had to be done prior to midnight for the safety of the researchers. Therefore, no analysis of the area was made during what the

researchers recognized as higher crime prevalence times in the late night and early morning hours.

In addition to problems with the CPTED evaluations, problems also arose from the basic premise of CPTED itself. First, none of the CPTED elements directly led to crime, but rather led to a greater risk of crime, as suggested by routine activity theory. For example, just because a homeowner left his or her front door open does not immediately, or definitely, result in crime; rather, this makes the house more *vulnerable* to crime. Lastly, the neighborhood size was not large enough, and the time period of the study was not long enough, to provide enough crime data to discern any significant statistical correlation with CPTED principles. For example, though cameras were installed in the target area over the course of the study, no CPTED evaluation was conducted after their activation to incorporate the cameras into CPTED scores and evaluate the correlation of CPTED vulnerability to crime rates. Crime rates are external factors that cannot be controlled, and the number of crimes occurring at 62 of the properties within the area of interest was insufficient to show a significant statistical correlation with CPTED vulnerability scores.

Some limitations also arose from the design of the CPTED scale. The literature regarding CPTED did not provide sufficient support for an attempt at accurate scoring of the relative importance of certain CPTED features. Instead of subjectively attempting to assign weighting to values, the scale was designed to give equal weight to each factor. In addition, some categories cancelled out other categories, making it impossible for a property to receive the maximum score on the scale. For instance, a house fronted by a narrow sidewalk could not also be lacking a sidewalk. A similar but more significant problem was related to landscaping: if visibility of a building was significantly obscured by trees or other obstacles, the building could

not lose any points in the maintenance and accessibility categories because these features could not be seen. Such artifacts of the scale may have led to few properties with extreme scores, while most were clustered together near the middle of the scale.

The CPTED scores for each property were also inconsistent over time, which can at least be partially attributed to the nature of CPTED, since properties are only evaluated at certain discrete instances and data was not continuously collected. The period of CPTED scale evaluation also did not correspond perfectly with the period of crime data collection. Some of the variables on the scale, such as litter present in a yard, an open window, valuable items visible, or lighting were highly prone to change on a daily basis. For example, the resident could simply fail to turn on exterior lighting while the researchers evaluated the property, and then be penalized in the CPTED evaluation, even if most of the time exterior lighting was actually present. Moreover, no evaluations were conducted over extended school breaks when many students are absent from their homes and certain factors such as lighting or ownership may have changed. As such, these evaluations inherently provide an incomplete view of this housing over the course of a year, as a complete evaluation of present conditions was not recorded.

Concerning the CPTED scale, the researchers re-evaluated its efficacy after the first evaluation. The scale was revised after the first evaluation in an attempt to correct for redundant and contradictory categories, and to separate static and fluctuating variables. Although the scale had high inter-rater reliability, many of the categories were subjective, and may have resulted in different evaluations by observers with no background in criminology. Nevertheless, the researchers did all undergo similar CPTED training, which may have mitigated this limitation.

Concerning the data set, there were originally two temporally distinct evaluations, however these evaluations were grouped by property. Though it may have been due to variation

over time, there appeared to be consistency issues between the CPTED evaluations. This meant there were large score differences, even within certain categories of the evaluation. It was this variation and inconsistency that led the researchers to combine the two data sets to create one composite set of data, with one CPTED score for each property. This could be a limitation because this CPTED evaluation process did not take into account the variable of time. This may be problematic, especially concerning the nature of CPTED theory, since yards change over time, not only with seasonal growth, but also with maintenance. Such changes can greatly alter the way a yard is scored on a CPTED evaluation. Moreover, habits can change over time that could affect the evaluation, but the nature of combining the data sets means no changes were tracked over time.

Future Research

Further support for the results gleaned from the present study could be obtained from similar research that incorporates a control neighborhood in addition to the neighborhood subjected to the intervention. The control neighborhood, free from the influence of the intervention, would allow the separation of perception and crime changes due to the intervention from those due to other factors, like the incidence of high-profile crimes in the area. Additionally, research based upon a larger geographical area may introduce more spatial variation in CPTED vulnerability and incorporate more crimes into the analysis. Future studies should aim to extend the post-intervention time by as long as is feasible. A longer data-collection period would allow for the assessment of long-term changes in crime rates and resident perceptions of crime due to the intervention, especially when combined with a control area.

To improve the quality of the CPTED scale evaluations, variables such as locked doors and security systems should be included in future analyses. However, homeowner cooperation would likely be needed in order to test these variables, which may lead to observation bias. Homeowner cooperation would also be required for the direct manipulation of CPTED variables, such as installing more secure locks or adding exterior lighting, but such changes would allow for a more comprehensive evaluation of CPTED principles.

After implementing the CCTV cameras and analyzing their effect on crime rates and student perceptions of crime the team would recommend other CPTED implementations in the area. While conducting site assessments in the Old Town it became clear that two major CPTED vulnerabilities present throughout the area were poor lighting and excessive foliage. Unfortunately, the team was unable to assess these issues since we were unable to gain access to individual properties and make changes ourselves. However, the team recommends that future research be done in evaluating the relationship between lighting and sight lines and crime rates.

Overall, this study represents a significant step forward into previously untested criminology theory within a university setting. Future research may build on these results by addressing limitations and providing concrete conclusions that can lead to policy changes and an improvement of public safety.

Appendices

Appendix A: CPTED Scale

ADDRESS: _____
DATE: _____ TIME: _____

Lighting (+1 if true)

- Street lighting not present within ~25 feet / poor street lighting.
- Present lighting is inconsistent.
- Home exterior lighting missing or off
- Lighting is inadequate (brightness –could you see people far way? Is yard illuminated?).

Yard maintenance

- Trash is present.
- Yard is unkempt.
- Bushes obscuring visibility (sight lines / light obstructed)
- Unseemly objects beyond trash present.

Home Exterior Maintenance

- Paint chipping
- Windows broken
- Home seems unkempt / unwelcoming
- Need for major repair

Accessibility of Valuables

- Valuables visible in yard
- Valuables within sight inside
- Door open / cracked
- Windows / open cracked within sight.

Territoriality

- No barrier between yard or sidewalk (or road, if no sidewalk)
- No items that establish ownership (flowerboxes, flags)
- No evidence of human presence (newspapers), place feels abandoned
- No boundary with yard next door

Guardianship (the presence of people)

- There is no sidewalk present or sidewalk is narrow
- No blue light in vicinity
- Foot traffic not quantifiable
- Vehicle traffic not present
- No visible cameras

Visibility / Sight lines

- Hiding places present
- No clear escape route

TOTAL SCORE: _____

Other notes:

Appendix B: Perception Survey for Residents of Old Town

Crime Prevention and Perception in College Park Survey (FOR RESIDENTS)

Thank you for choosing to participate in our survey.

We are Crime Prevention & Perception, an undergraduate research team in the Gemstone Program of the University of Maryland. For more information, please visit our website: <http://teams.gemstone.umd.edu/classof2011/cp2/>.

The following survey was designed to assess perceptions of crime in off-campus housing near the University of Maryland's College Park campus.

PLEASE NOTE - All questions in this survey relate to the neighborhood where you CURRENTLY live in College Park. Accordingly, please respond to all questions in terms of your College Park residence only (NOT your hometown or other residences). Also, be sure to read each question carefully, as several of the questions and answer choices will look very similar.

The entire survey will take approximately 10 minutes to complete.

Below you will find an overview of our research study. At the bottom of the page will be a place for you to write your name and date, which serves as an electronic signature for our consent form. Please be sure to fill in the required fields, or else you will be unable to proceed with the survey.

Research Description and Participant Consent Form

PROJECT TITLE: Crime Prevention and Perception

WHY IS THIS RESEARCH BEING DONE?

This is a research project being conducted by the Crime Prevention and Perception team of the Gemstone Program at the University of Maryland, College Park. We are inviting you to participate in this research project because you currently reside in a neighborhood that is of interest to our study. The purpose of this research project is to gauge your history of victimization, awareness, and perception of crime in your current residential environment.

WHAT WILL I BE ASKED TO DO?

The procedures involve completing an online survey that will ask various questions concerning demographic status, history of victimization, neighborhood cohesion, concern for community, feeling of safety or worry, avoidance of crime, and community policing. There is no specific location for the completion of the survey. You will be asked to complete them at your convenience. The survey will take no longer than fifteen minutes.

WHAT ABOUT CONFIDENTIALITY?

We will keep your personal information confidential. To help protect your confidentiality, all survey administrators will keep restricted your name and all information gathered about you. The survey will remain anonymous and will not ask for your address or contact information. Survey administrators will exercise caution to prevent others from accessing the survey data.

WHAT ARE THE RISKS OF THIS RESEARCH?

There may be some risks from participating in this research study. The survey will include questions related to your past victimization and perception of current exposure to crime. The risks that may arise from this survey could be due to the nature of the survey questions and could include revival of repressed memories, emotional disturbance, embarrassment, increased fear, sadness, distress, stress, and heightened paranoia.

WHAT ARE THE BENEFITS OF THIS RESEARCH?

This research is not designed to help you personally, but the results may help the investigator learn more about the perception of crime in your area. By surveying you, the investigator will be able to determine possible areas of vulnerability in your environment. Results of the project may help to encourage initiatives to enhance safety in the College Park general community.

DO I HAVE TO BE IN THIS RESEARCH? MAY I STOP PARTICIPATING AT ANY TIME?

Your participation in this research is completely voluntary. You may choose not to take part at all. If you decide to participate in this research, you may stop participating at any time. If you decide not to participate in this study or if you stop participating at any time, you will not be penalized or lose any benefits to which you otherwise qualify.

WHAT IF I HAVE QUESTIONS?

This research is being conducted by Dr. Charles Wellford of the Criminology Department at the University of Maryland, College Park. If you have any questions about the research study itself, please contact Dr. Charles Wellford at: 2220 Lefrak Hall, cwellford@crim.umd.edu.

If you have questions about your rights as a research subject or wish to report a research-related injury, please contact: Institutional Review Board Office, University of Maryland, College Park, Maryland, 20742; (e-mail) irb@deans.umd.edu; (telephone) 301-405-0678.

This research has been reviewed according to the University of Maryland, College Park IRB procedures for research involving human subjects.

Counseling services are available on campus. Feel free to contact the Counseling Center at: The University of Maryland, Susquehanna Hall at 301-314-7651.

STATEMENT OF AGE OF SUBJECT AND CONSENT

Checking the box below indicates that:

- you are at least 18 years of age;
- the research has been explained to you;
- your questions have been fully answered; and
- you freely and voluntarily choose to participate in this research project.

1. Consent Form Confirmation *

"By checking this box, I acknowledge to have read the consent form above, and voluntarily agree to become a participant in this research study."

Yes, I agree.

2. What is your age?

3. If you are a student, what level of education are you pursuing?

- Undergraduate
- Graduate
- I am not a student

4. What is your expected graduation date?

(Example: Spring 2011)

5. Please indicate your gender.

- Male
- Female

6. Which of the following best describes your racial or ethnic background?

Please check all that apply.

- Asian
- Black or African American
- White or Caucasian
- Hispanic
- Native American

7. What is your current living arrangement (in College Park)?

- Living with parents
- Living in a one-person household
- Living with roommate(s)
- Living with a partner but without children
- Living with a partner and child(ren)
- Living with child(ren) but without a partner

8. How long have you stayed at your current residence (in College Park)?

9. On a scale of 1 to 10, please rate the following:

How afraid are you of being a victim of crime?

1 2 3 4 5 6 7 8 9 10

Not afraid at all Very afraid

10. On a scale of 1 to 10, please rate the following:

How likely do you think you will be a victim of crime?

1 2 3 4 5 6 7 8 9 10

Not likely at all Very Likely

11. At which of the following times of day do you think the most crime in your area takes place?

- Early hours (2am-6am)
- Early morning (6am-9am)
- Morning (9am-12pm)
- Afternoon (12pm-5pm)
- Early evening (5pm-8pm)
- Late evening/night(8pm-11 pm)
- The midnight hours (11 pm-2am)

12. How safe do you feel in the following situation?

	Not safe at all	Fairly unsafe	Neutral	Fairly safe	Very safe
At home alone during the day	<input type="radio"/>	<input type="radio"/>	<input type="radio"/>	<input type="radio"/>	<input type="radio"/>
At home alone at night	<input type="radio"/>	<input type="radio"/>	<input type="radio"/>	<input type="radio"/>	<input type="radio"/>
Walking alone during the day in your neighborhood block	<input type="radio"/>	<input type="radio"/>	<input type="radio"/>	<input type="radio"/>	<input type="radio"/>
Walking alone at night in your neighborhood block	<input type="radio"/>	<input type="radio"/>	<input type="radio"/>	<input type="radio"/>	<input type="radio"/>

13. How much do you think the following are problems in your neighborhood?

	Not a problem at all	A slight problem	Neutral	A fairly serious problem	A very serious problem
Auto theft	<input type="radio"/>	<input type="radio"/>	<input type="radio"/>	<input type="radio"/>	<input type="radio"/>
Disturbances caused by neighbors	<input type="radio"/>	<input type="radio"/>	<input type="radio"/>	<input type="radio"/>	<input type="radio"/>
Harassment because of race and/or ethnic background	<input type="radio"/>	<input type="radio"/>	<input type="radio"/>	<input type="radio"/>	<input type="radio"/>
Illegal drug use and/or dealing drugs	<input type="radio"/>	<input type="radio"/>	<input type="radio"/>	<input type="radio"/>	<input type="radio"/>
Physical assaults (including sexual assaults)	<input type="radio"/>	<input type="radio"/>	<input type="radio"/>	<input type="radio"/>	<input type="radio"/>
Residential burglary	<input type="radio"/>	<input type="radio"/>	<input type="radio"/>	<input type="radio"/>	<input type="radio"/>
Street robbery or muggings	<input type="radio"/>	<input type="radio"/>	<input type="radio"/>	<input type="radio"/>	<input type="radio"/>
Theft from grounds or shed/garage	<input type="radio"/>	<input type="radio"/>	<input type="radio"/>	<input type="radio"/>	<input type="radio"/>
Vandalism to or theft from auto	<input type="radio"/>	<input type="radio"/>	<input type="radio"/>	<input type="radio"/>	<input type="radio"/>
Vandalism, graffiti, or damage to property (other than auto)	<input type="radio"/>	<input type="radio"/>	<input type="radio"/>	<input type="radio"/>	<input type="radio"/>

14. To what extent are you worried about crime in this area?

- Not at all worried
- Not very worried
- Fairly worried
- Very worried

15. If you are worried about being a victim of crime, what are some of your reasons for feeling this way?

(Check all that apply.)

- I have experienced it before
- I know someone who has experienced it before
- I have heard stories of it happening to other people
- I have read articles in the Diamondback newspaper that describe crimes that have occurred in this area of College Park
- I have read crime alerts sent by the University of Maryland Police Department that describe crimes that have occurred in this area
- Specific individuals in this area worry me
- This area has a bad reputation for crime
- None, I am not worried about being a victim of crime
- Other:

16. What do you think are the causes of crime in your neighborhood? (Check all that apply.)

(Check all that apply.)

- Alcohol related reasons
- Drug related reasons
- Not enough police presence
- Easy access to property
- Unemployment
- Low incomes
- Professional criminals
- Lack of community cooperation
- The other tenants do not take crime prevention seriously

17. Would you say you feel less safe or safer in your neighborhood than you did 12 months ago?

- Much less safe
- A bit less safe
- About the same
- A bit safer
- Much safer
- N/A

18. How friendly are your relationships with most neighbors?

- Very hostile
- Somewhat hostile
- Indifferent
- Somewhat friendly
- Very friendly

19. How much do you trust your neighbors?

- I do not trust them at all
- I distrust them quite a bit
- Neutral
- I trust them somewhat
- I trust them very much

20. Does your community have a neighborhood watch?

- Yes
- No
- Don't Know

21. If yes, do you participate in the neighborhood watch meetings and/or events?

- Yes
- No
- N/A

22. In general, how do you feel about security cameras?

1 2 3 4 5 6 7 8 9 10

Very negatively Very positively

23. Are there any security cameras within a 100-meter radius of your building?

- Yes
- No
- Don't Know

24. To what extent do you agree or disagree with the following statements?

	Strongly disagree	Disagree	Neutral	Agree	Strongly agree
Security cameras would help to deter criminal activity.	<input type="radio"/>	<input type="radio"/>	<input type="radio"/>	<input type="radio"/>	<input type="radio"/>
I would feel safer if more security cameras were implemented in this area.	<input type="radio"/>	<input type="radio"/>	<input type="radio"/>	<input type="radio"/>	<input type="radio"/>

25. To what extent do you agree or disagree with the following statements?

	Strongly disagree	Disagree	Neutral	Agree	Strongly agree
Policing in this area is successful in tackling crime overall.	<input type="radio"/>	<input type="radio"/>	<input type="radio"/>	<input type="radio"/>	<input type="radio"/>
The Prince George's County Police successfully reduces crime and anti-social behavior.	<input type="radio"/>	<input type="radio"/>	<input type="radio"/>	<input type="radio"/>	<input type="radio"/>
The University Police/Police Auxiliary successfully reduces crime and anti-social behavior.	<input type="radio"/>	<input type="radio"/>	<input type="radio"/>	<input type="radio"/>	<input type="radio"/>
The Prince George's County Police interacts with people in your local area	<input type="radio"/>	<input type="radio"/>	<input type="radio"/>	<input type="radio"/>	<input type="radio"/>
The University Police/Police Auxiliary interacts with people in your local area	<input type="radio"/>	<input type="radio"/>	<input type="radio"/>	<input type="radio"/>	<input type="radio"/>
Your neighborhood is a safe place to live.	<input type="radio"/>	<input type="radio"/>	<input type="radio"/>	<input type="radio"/>	<input type="radio"/>

26. Please respond to the following questions.

	No, not at all	No, not much	Neutral	Yes, to some extent	Yes, fully
Do you feel the police in this area understand the concerns of the people living in this neighborhood?	<input type="radio"/>	<input type="radio"/>	<input type="radio"/>	<input type="radio"/>	<input type="radio"/>
Do you think the police in this area take the concerns of the people living in this neighborhood seriously?	<input type="radio"/>	<input type="radio"/>	<input type="radio"/>	<input type="radio"/>	<input type="radio"/>

27. How worried are you about being a victim of the following?

	Not at all worried	Not very worried	Neutral	Fairly worried	Very worried
Auto theft	<input type="radio"/>	<input type="radio"/>	<input type="radio"/>	<input type="radio"/>	<input type="radio"/>
Disturbances caused by people in the area	<input type="radio"/>	<input type="radio"/>	<input type="radio"/>	<input type="radio"/>	<input type="radio"/>
Harassment because of race and/or ethnic background	<input type="radio"/>	<input type="radio"/>	<input type="radio"/>	<input type="radio"/>	<input type="radio"/>
Illegal drug use and/or dealing drugs	<input type="radio"/>	<input type="radio"/>	<input type="radio"/>	<input type="radio"/>	<input type="radio"/>
Physical assaults (including sexual assaults)	<input type="radio"/>	<input type="radio"/>	<input type="radio"/>	<input type="radio"/>	<input type="radio"/>
Residential burglary	<input type="radio"/>	<input type="radio"/>	<input type="radio"/>	<input type="radio"/>	<input type="radio"/>
Street robbery or muggings	<input type="radio"/>	<input type="radio"/>	<input type="radio"/>	<input type="radio"/>	<input type="radio"/>
Theft from grounds or shed/garage	<input type="radio"/>	<input type="radio"/>	<input type="radio"/>	<input type="radio"/>	<input type="radio"/>
Vandalism to or theft from auto	<input type="radio"/>	<input type="radio"/>	<input type="radio"/>	<input type="radio"/>	<input type="radio"/>
Vandalism, graffiti, or damage to property (other than auto)	<input type="radio"/>	<input type="radio"/>	<input type="radio"/>	<input type="radio"/>	<input type="radio"/>

28. Please answer "Yes" or "No" to the following questions.

	Yes	No
Do you generally avoid going out after dark?	<input type="radio"/>	<input type="radio"/>
Do you generally avoid answering the door after dark?	<input type="radio"/>	<input type="radio"/>
Do you avoid groups of people on the street?	<input type="radio"/>	<input type="radio"/>
Do you avoid using public transport alone after dark?	<input type="radio"/>	<input type="radio"/>
Do you avoid going out alone?	<input type="radio"/>	<input type="radio"/>
Do you avoid leaving your house unoccupied?	<input type="radio"/>	<input type="radio"/>

29. In your neighborhood, which of the following are present?

(Check all that apply.)

- Emergency telephones
- External lighting
- Maintenance of building (ie. buildings are properly maintained)
- Maintenance of landscape (trimming bushes, planting flowers, etc)
- Police patrol in the community
- Sidewalks
- Security cameras

30. Which of the following crimes have you personally experienced in the last 12 months?

- Auto theft
- Disturbances caused by neighbors
- Harassment because of race and/or ethnic background
- Illegal drug use and/or dealing drugs
- Physical assaults (including sexual assaults)
- Residential burglary
- Street robbery or muggings
- Theft from grounds or shed/garage
- Vandalism to or theft from auto
- Vandalism, graffiti, or damage to property (other than auto)
- None of the above
- Other:

31. Did you report the crimes that you experienced (if any) to the police or any other agency?

- Yes
- No
- N/A

32. If reported: Who did you report this crime to?

(Check all that apply.)

- Landlord
- University of Maryland Police
- Prince George's County Police
- Neighborhood Watch
- N/A
- Other:

33. If reported: Please rate your satisfaction with the response you received after reporting the crime.

	Very dissatisfied	Fairly dissatisfied	Neutral	Fairly satisfied	Very satisfied
Courtesy of the police	<input type="radio"/>	<input type="radio"/>	<input type="radio"/>	<input type="radio"/>	<input type="radio"/>
Speed of response	<input type="radio"/>	<input type="radio"/>	<input type="radio"/>	<input type="radio"/>	<input type="radio"/>
Knowledge of the local area and local issues	<input type="radio"/>	<input type="radio"/>	<input type="radio"/>	<input type="radio"/>	<input type="radio"/>
Effectiveness of response	<input type="radio"/>	<input type="radio"/>	<input type="radio"/>	<input type="radio"/>	<input type="radio"/>
The follow-up information and support you received	<input type="radio"/>	<input type="radio"/>	<input type="radio"/>	<input type="radio"/>	<input type="radio"/>

34. If NOT reported: Which of the following factors, if any, caused you to not report the crime?

(Check all that apply.)

- I did not think it was serious enough
- I could not be bothered to report it
- Someone else reported it
- The police would not be able to do anything
- The police would not take the crime seriously/would not be interested
- The police were too busy
- I was able to sort the problem out myself
- It was unlikely that the criminal(s) would get caught
- I was scared of revenge attacks/reprisals
- N/A
- Other:

35. Which of the following do you have at your College Park residence?

(Check all that apply.)

- Door locks
- Window locks
- Home security system
- Door viewer or peephole
- Other:

36. Which of the following do you USE to protect your College Park residence? (Check all that apply.)

(Check all that apply.)

- Door locks
- Window locks
- Home security system
- Door viewer or peephole
- Other:

37. If you have a car, which of the following precautions do you take?

(Check all that apply.)

- Park in a visible area
- Lock the doors and trunk
- Keep any valuables out of sight
- Use an alarm system
- Use a steering wheel lock
- Keep it in a garage
- Have it registered with an auto theft retrieval service
- N/A - I don't have a car
- Other:

38. Which of the following precautions do you usually take to ensure your personal safety?

(Check all that apply.)

- Check the identity of visitors to your home
- Avoid certain streets or areas
- Let someone know where you have gone when out
- Carry a mobile phone for safety reasons when out
- Carry a whistle or other noisemaker when out
- Carry a protective device (pepper spray, pocket knife, etc.) when out
- Walk in a group
- Other:

39. Please let us know if you have any other suggestions or comments about our survey.

You are done!

If you have any questions, please feel free to contact us at cp2.umd@gmail.com or visit our website: <http://teams.gemstone.umd.edu/classof2011/cp2/>.

Thanks again for completing the survey!

Appendix C: Perception Survey for Non-Residents

Crime Prevention and Perception in College Park Survey (FOR NON-RESIDENTS)

Welcome and thank you for choosing to participate in our survey.

We are Crime Prevention & Perception, an undergraduate research team in the Gemstone Program of the University of Maryland. For more information, please visit our website: <http://teams.gemstone.umd.edu/classof2011/cp2/>.

The following survey was designed to assess perceptions of crime in off-campus housing areas near the University of Maryland's College Park campus.

PLEASE NOTE - All questions in this survey refer to the Old Historic Town neighborhoods of College Park. Accordingly, please respond to all questions in terms of the Old Town area (NOT with your hometown or other neighborhoods). Also, be sure to read each question carefully, as several of the questions and answer choices will look very similar.

The entire survey will take approximately 10 minutes to complete.

On the next page you will find an overview of our research study. At the bottom of the page will be a place for you to write your name and date, which serves as an electronic signature for our consent form. Please be sure to fill in the required fields, or else you will be unable to proceed with the survey.

Research Description and Participant Consent Form

PROJECT TITLE: Crime Prevention and Perception

WHY IS THIS RESEARCH BEING DONE?

This is a research project being conducted by the Crime Prevention and Perception team of the Gemstone Program at the University of Maryland, College Park. We are inviting you to participate in this research project because your perceptions of crime in College Park are valuable to our study. The purpose of this research project is to gauge your history of victimization, awareness, and perception of crime in the Old Historic Town of College Park.

WHAT WILL I BE ASKED TO DO?

The procedures involve completing an online survey that will ask various questions concerning demographic status, history of victimization, neighborhood cohesion, concern for community, feeling of safety or worry, avoidance of crime, and community policing. There is no specific location for the completion of the survey. You will be asked to complete them at your convenience. The survey will take no longer than fifteen minutes.

WHAT ABOUT CONFIDENTIALITY?

We will keep your personal information confidential. To help protect your confidentiality, all survey administrators will keep restricted your name and all information gathered about you. The survey will remain anonymous and will not ask for your address or contact information. Survey administrators will exercise caution to prevent others from accessing the survey data.

WHAT ARE THE RISKS OF THIS RESEARCH?

There may be some risks from participating in this research study. The survey will include questions related to your past victimization and perception of current exposure to crime. The risks that may arise from this survey could be due to the nature of the survey questions and could include revival of repressed memories, emotional disturbance, embarrassment, increased fear, sadness, distress, stress, and heightened paranoia.

WHAT ARE THE BENEFITS OF THIS RESEARCH?

This research is not designed to help you personally, but the results may help the investigator learn more about the perception of crime in College Park. By surveying you, the investigator will be able to determine possible areas of vulnerability in this environment. Results of the project may help to encourage initiatives to enhance safety in the College Park general community.

DO I HAVE TO BE IN THIS RESEARCH? MAY I STOP PARTICIPATING AT ANY TIME?

Your participation in this research is completely voluntary. You may choose not to take part at all. If you decide to participate in this research, you may stop participating at any time. If you decide not to participate in this study or if you stop participating at any time, you will not be penalized or lose any benefits to which you otherwise qualify.

WHAT IF I HAVE QUESTIONS?

This research is being conducted by Dr. Charles Wellford of the Criminology Department at the University of Maryland, College Park. If you have any questions about the research study itself, please contact Dr. Charles Wellford at: 2220 Lefrak Hall, cwellford@crim.umd.edu.

If you have questions about your rights as a research subject or wish to report a research-related injury, please contact: Institutional Review Board Office, University of Maryland, College Park, Maryland, 20742; (e-mail) irb@deans.umd.edu; (telephone) 301-405-0678.

This research has been reviewed according to the University of Maryland, College Park IRB procedures for research involving human subjects.

Counseling services are available on campus. Feel free to contact the Counseling Center at: The University of Maryland, Susquehanna Hall at 301-314-7651.

STATEMENT OF AGE OF SUBJECT AND CONSENT

Checking the box below indicates that:

- you are at least 18 years of age;
- the research has been explained to you;
- your questions have been fully answered; and
- you freely and voluntarily choose to participate in this research project.

1. Consent Form Confirmation *

"By checking this box, I acknowledge to have read the consent form above, and voluntarily agree to become a participant in this research study."

Yes, I agree.

2. What is your age?

3. If you are a student, what level of education are you pursuing?

- Undergraduate
- Graduate
- I am not a student

4. What is your expected graduation date?

(Example: Spring 2011)

5. Please indicate your gender.

- Male
- Female

6. Which of the following best describes your racial or ethnic background?

Please check all that apply.

- Asian
- Black or African American
- White or Caucasian
- Hispanic
- Native American

7. How often do you spend time in the Old Historic Town College Park area?

- Almost everyday
- About once a week
- Once or twice a month
- Very rarely (or never)

8. At what time of day do you usually visit this area?

(Check all that apply.)

- In the morning
- In the afternoon
- In the evening/night
- During the late night or early morning hours
- N/A

9. At which of the following times of day do you think the most crime in the area takes place?

- Early hours (2am-6am)
- Early morning (6am-9am)
- Morning (9am-12pm)
- Afternoon (12pm-5pm)
- Early evening (5pm-8pm)
- Late evening/night(8pm-11 pm)
- The midnight hours (11pm-2am)

10. How safe do you feel in the following situation?

	Not safe at all	Fairly unsafe	Neutral	Fairly safe	Very safe
Walking alone during the day in this area	<input type="radio"/>	<input type="radio"/>	<input type="radio"/>	<input type="radio"/>	<input type="radio"/>
Walking alone at night in this area	<input type="radio"/>	<input type="radio"/>	<input type="radio"/>	<input type="radio"/>	<input type="radio"/>

11. On a scale of 1 to 10, please rate the following:

How likely do you think you will be a victim of crime?

1 2 3 4 5 6 7 8 9 10

Not likely at all Very Likely

12. To what extent are you worried about crime in this area?

- Not at all worried
- Not very worried
- Fairly worried
- Very worried

13. If you are worried about being a victim of crime, what are some of your reasons for feeling this way?

(Check all that apply.)

- I have experienced it before
- I know someone who has experienced it before
- I have heard stories of it happening to other people
- I have read articles in the Diamondback newspaper that describe crimes that have occurred in this area of College Park
- I have read crime alerts sent by the University of Maryland Police Department that describe crimes that have occurred in this area
- Specific individuals in this area worry me
- This area has a bad reputation for crime
- None, I am not worried about being a victim of crime
- Other:

14. What do you think are the causes of crime in this area?

(Check all that apply.)

- Alcohol related reasons
- Drug related reasons
- Not enough police presence
- Easy access to property
- Unemployment
- Low incomes
- Professional criminals
- Lack of community cooperation
- The other tenants do not take crime prevention seriously

15. In general, how do you feel about security cameras?

1 2 3 4 5 6 7 8 9 10

Very negatively Very positively

16. Are there any security cameras in this area?

- Yes
- No
- Don't Know

17. To what extent do you agree or disagree with the following statements?

	Strongly disagree	Disagree	Neutral	Agree	Strongly agree
Security cameras would help to deter criminal activity.	<input type="radio"/>	<input type="radio"/>	<input type="radio"/>	<input type="radio"/>	<input type="radio"/>
I would feel safer if more security cameras were implemented in this area.	<input type="radio"/>	<input type="radio"/>	<input type="radio"/>	<input type="radio"/>	<input type="radio"/>

18. To what extent do you agree or disagree with the following statements?

	Strongly disagree	Disagree	Neutral	Agree	Strongly agree
Policing in this area is successful in tackling crime overall.	<input type="radio"/>	<input type="radio"/>	<input type="radio"/>	<input type="radio"/>	<input type="radio"/>
The Prince George's County Police successfully reduces crime and anti-social behavior.	<input type="radio"/>	<input type="radio"/>	<input type="radio"/>	<input type="radio"/>	<input type="radio"/>
The University Police/Police Auxiliary successfully reduces crime and anti-social behavior.	<input type="radio"/>	<input type="radio"/>	<input type="radio"/>	<input type="radio"/>	<input type="radio"/>
This area is a safe place to be.	<input type="radio"/>	<input type="radio"/>	<input type="radio"/>	<input type="radio"/>	<input type="radio"/>

19. How worried are you about being a victim of the following?

	Not at all worried	Not very worried	Neutral	Fairly worried	Very worried
Auto theft	<input type="radio"/>	<input type="radio"/>	<input type="radio"/>	<input type="radio"/>	<input type="radio"/>
Disturbances caused by people in the area	<input type="radio"/>	<input type="radio"/>	<input type="radio"/>	<input type="radio"/>	<input type="radio"/>
Harassment because of race and/or ethnic background	<input type="radio"/>	<input type="radio"/>	<input type="radio"/>	<input type="radio"/>	<input type="radio"/>
Illegal drug use and/or dealing drugs	<input type="radio"/>	<input type="radio"/>	<input type="radio"/>	<input type="radio"/>	<input type="radio"/>
Physical assaults (including sexual assaults)	<input type="radio"/>	<input type="radio"/>	<input type="radio"/>	<input type="radio"/>	<input type="radio"/>
Street robbery or muggings	<input type="radio"/>	<input type="radio"/>	<input type="radio"/>	<input type="radio"/>	<input type="radio"/>
Vandalism to or theft from auto	<input type="radio"/>	<input type="radio"/>	<input type="radio"/>	<input type="radio"/>	<input type="radio"/>

20. On a scale of 1 to 10, please rate the following:

How afraid are you of being a victim of crime?

1 2 3 4 5 6 7 8 9 10

Not afraid at all Very afraid

21. Which of the following are present in this area?

(Check all that apply.)

- Emergency telephones
- External lighting
- Maintenance of building (ie. buildings are properly maintained)
- Maintenance of landscape (trimming bushes, planting flowers, etc)
- Police patrol in the community
- Sidewalks
- Security cameras

22. Please answer "Yes" or "No" to the following questions.

	Yes	No
Do you generally avoid going out after dark?	<input type="radio"/>	<input type="radio"/>
Do you avoid groups of people on the street?	<input type="radio"/>	<input type="radio"/>
Do you avoid using public transport alone after dark?	<input type="radio"/>	<input type="radio"/>
Do you avoid going out alone?	<input type="radio"/>	<input type="radio"/>

23. Which of the following crimes have you personally experienced in the last 12 months?

- Auto theft
- Disturbances caused by neighbors
- Harassment because of race and/or ethnic background
- Illegal drug use and/or dealing drugs
- Physical assaults (including sexual assaults)
- Residential burglary
- Street robbery or muggings
- Theft from grounds or shed/garage
- Vandalism to or theft from auto
- Vandalism, graffiti, or damage to property (other than auto)
- None of the above
- Other:

24. Did you report the crimes that you experienced (if any) to the police or any other agency?

- Yes
- No
- N/A

25. If reported: Who did you report this crime to?

(Check all that apply.)

- Landlord
- University of Maryland Police
- Prince George's County Police
- Neighborhood Watch
- N/A
- Other:

26. If reported: Please rate your satisfaction with the response you received after reporting the crime.

	Very dissatisfied	Fairly dissatisfied	Neutral	Fairly satisfied	Very satisfied
Courtesy of the police	<input type="radio"/>	<input type="radio"/>	<input type="radio"/>	<input type="radio"/>	<input type="radio"/>
Speed of response	<input type="radio"/>	<input type="radio"/>	<input type="radio"/>	<input type="radio"/>	<input type="radio"/>
Knowledge of the local area and local issues	<input type="radio"/>	<input type="radio"/>	<input type="radio"/>	<input type="radio"/>	<input type="radio"/>
Effectiveness of response	<input type="radio"/>	<input type="radio"/>	<input type="radio"/>	<input type="radio"/>	<input type="radio"/>
The follow-up information and support you received	<input type="radio"/>	<input type="radio"/>	<input type="radio"/>	<input type="radio"/>	<input type="radio"/>

27. If NOT reported: Which of the following factors, if any, caused you to not report the crime?

(Check all that apply.)

- I did not think it was serious enough
- I could not be bothered to report it
- Someone else reported it
- The police would not be able to do anything
- The police would not take the crime seriously/would not be interested
- The police were too busy
- I was able to sort the problem out myself
- It was unlikely that the criminal(s) would get caught
- I was scared of revenge attacks/reprisals
- N/A
- Other:

28. Please let us know if you have any other suggestions or comments about our survey.

You are done!

If you have any questions, please feel free to contact us at cp2.umd@gmail.com or visit our website: <http://teams.gemstone.umd.edu/classof2011/cp2/>.

Thanks again for completing the survey!

Appendix D: Crime Coding Key

Streets

- 1 - Baltimore Ave
- 2 - Calvert Ave
- 3 - College Ave
- 4 - Hartwick Rd
- 5 - Hopkins Ave
- 6 - Knox Rd
- 7 - Princeton Ave
- 8 - Rhode Island Ave
- 9 - Dickinson Avenue
- 10 - Dartmouth Avenue
- 12 - Norwich Road
- 13 - College Ave, Rhode Island Ave
- 14 - Knox Rd, Dickinson Ave
- 15 - Knox Rd, Princeton Ave
- 16 - College Ave, Dartmouth Ave
- 17 - College Ave, Dickinson Ave
- 18 - Hartwick Rd, Princeton Ave

Type of Crime

- 1 - Theft
- 2 - RBE
- 3 - Attempted RBE
- 4 - Citizen robbery
- 5 - Attempted citizen strong-arm robbery
- 6 - Theft from auto
- 10 - Residential robbery
- 12 - RBE and auto theft
- 13 - RBE and assault

Number of Criminals

- 11 - unknown

Race of Criminals

- 1 - White
- 2 - Black
- 3 - Hispanic
- 4 - Asian
- 5 - Mixed
- 9 - Other
- 11 - Unknown

Gender of Criminals

- 1 - Male
- 2 - Female
- 5 - Mixed
- 11 - Unknown

Number of Victims

- 11 - unknown

Race of Victims

- 1 - White
- 2 - Black
- 3 - Hispanic
- 4 - Asian
- 5 - Mixed
- 9 - Other

Gender of Victims

- 1 - Male
- 2 - Female
- 5 - Mixed

Status

- 1 - Student
- 2 - Non-student
- 11 - Unknown

Time of Day

- 1 - Day-time
- 2 - Night-time
- 11 - Unknown

Break

- 1 - Winter
- 2 - Summer
- 3 - Spring
- 4 - Thanksgiving
- 0 - None

Reporting Time

- 1 - Within 1 hr
- 2 - \leq 24 hrs
- 3 - \leq 1 week
- 4 - $>$ 1 week
- 11 - Unknown

Anyone Present

- 1 - Yes
- 2 - No
- 10 - N/A
- 11 - Unknown

Home Security

- 1 - Locked
- 2 - Unlocked
- 10 - N/A
- 11 - Unknown

Weapons

- 1 - Gun
- 9 - Other
- 11 - Unknown
- 0 - None

Items Stolen

- 1 - Inside home
- 2 - Outside home
- 3 - On person
- 4 - Inside car
- 9 - Other
- 11 - Unknown
- 0 - None

Damages

- 1 - Door
- 2 - Window
- 3 - Access to item
- 4 - Door and Window
- 9 - Other
- 11 - Unknown
- 0 - None

Victim Injuries

- 1 - Yes
- 2 - No
- 11 - Unknown

Appendix E: Extended Acknowledgements

The following people were indispensable in their assistance to the team. Their expertise and support are greatly appreciated.

Brad Bartholomew

Ph.D. Candidate

Department of Criminology and Criminal Justice

University of Maryland

Mr. Bartholomew assisted the research team in the development of the research design.

Phil Cantor

Crime Analyst

Baltimore County Police Department

Mr. Cantor gave a training workshop on ArcGIS and CrimeSTAT. He helped the research team use the software to map the original crime data.

Major Kevin Davis

Prince George's County Police Department

Major Davis helped the research team establish relations with the Prince George's County Police Department.

Andrew Fellows

City of College Park Mayor

Mayor Fellows extended his full support to the team's efforts and welcomed cooperation between the researchers and the City council.

Dr. John Firman

Director of Research

International Association of Chiefs of Police

Dr. Firman served as a panelist at the team's thesis defense on April 2, 2011.

Dr. Joel Garner

Director of Law Enforcement Statistics

Bureau of Justice Statistics

Dr. Garner served as a panelist at the team's thesis defense on April 2, 2011.

Major Robert Liberati

Prince George's County Police Department

Major Liberati was the key contact person in getting access to the crime data. He also served as a discussant at the thesis defense on April 2, 2011.

Dr. Cynthia Lum

Deputy Director

Center for Evidence-Based Crime Policy

George Mason University

Dr. Lum provided recommendations to the team's research and served as a discussant at the team's thesis proposal presentation.

Mr. David Mazeika

Ph.D candidate

Department of Criminology and Criminal Justice

University of Maryland

Mr. Mazeika assisted the researchers in the development of the research design.

Dr. Jean McGloin

Assistant Professor

Department of Criminology and Criminal Justice

University of Maryland

Dr. McGloin provided valuable guidance on the research design of the project. She also served as a discussant at the researcher's thesis proposal presentation and defense.

Lisa Miller

President

Terp Real Estate and Management

Ms. Miller extended her support to the team's efforts in addressing crime in College Park and provided the researchers with resources and information pertinent to the research project.

Dr. John Morgan

Deputy Director for Science and Technology

National Institute of Justice

Dr. Morgan introduced the researchers to a variety of technologies used in the criminal justice system.

Susan Riseling

Chief of Police/Associate Vice Chancellor

University of Madison – Wisconsin Police Department

Chief Riseling gave the researchers recommendations on the types of problems that could be addressed by the research based on her personal survey of the campus and interviews with

University Police and Prince George's County Police.

Bob Ryan

Director of Public Services

City of College Park

Bob Ryan facilitated a partnership between the researchers and the City and kept the researchers posted with updates on the installation of CCTV cameras in Old Town College Park.

Sgt. Harold Simms

Prince George's County Police Department

Sgt. Simms granted the researchers access to crime data and enabled the coding of crime reports.

Dr. David Soule

Executive Director

Maryland State Commission on Criminal Sentencing Policy

Dr. Soule served as a discussant at the thesis defense on April 2, 2011.

Dr. Richard Valliant

Research Professor

Joint Program in Survey Methodology

University of Maryland

Dr. Valliant assisted the researchers in designing a survey methodology.

Chief Larry Volz

Director of Public Safety/ Chief Police

University of District of Columbia Police Department

Chief Volz introduced the researchers to the theory of Crime Prevention Through Environmental Design through a presentation.

Lashawn Watts

Prince George's County Police Department

Ms. Watts greatly assisted the researchers by pulling crime reports and granting access to the crime reports for coding.

Dr. Diane Zahm

Associate Chair and Associate Professor

Urban Affairs and Planning

Virginia Polytechnic Institute and University

Dr. Zahm trained the researchers in understanding Crime Prevention Through Environmental Design theory and strategies. She helped the researchers to choose Old Town College Park as the focus area.

Appendix F: The Diamondback Articles

The Diamondback is an independent, daily student newspaper of the University of Maryland. The following is a comprehensive list of Diamondback articles related to crime, fear, safety, and/or the *Crime Prevention and Perception* team from January 2008 till December 2010.

Man evades police in car chase on Rt. 1

County police say suspect tied to two purse snatchings and tanning salon robbery

December 13, 2010 by Marissa Lang

<http://www.diamondbackonline.com/news/man-evades-police-in-car-chase-on-rt-1-1.1830107>

Police target student misconceptions

In addition to fighting crime, police and university officials are turning their attention to another threat that has infiltrated the student body — fear.

December 12, 2010 by Ben Present

<http://www.diamondbackonline.com/news/police-target-student-misconceptions-1.1830055>

GSG holds second annual safety walk

December 2, 2010 by Amanda Pino

<http://www.diamondbackonline.com/news/gsg-holds-second-annual-safety-walk-1.1815727>

Delivery man robbed at Knox and Guilford

Another man mugged at gunpoint leaving Greenbelt Metro

November 21, 2010 by Ben Present

[http://www.diamondbackonline.com/news/delivery-man-robbed-at-knox-and-guilford-](http://www.diamondbackonline.com/news/delivery-man-robbed-at-knox-and-guilford-1.1788792)

1.1788792

BREAKING: Student robbed in Mowatt Lane Garage

November 18, 2010 by Brady Holt

[http://www.diamondbackonline.com/news/breaking-student-robbed-in-mowatt-lane-garage-](http://www.diamondbackonline.com/news/breaking-student-robbed-in-mowatt-lane-garage-1.1784515)

1.1784515

Mugging on Mowatt stairs unsolved

Student robbed of ID, cell phone in garage

November 18, 2010

<http://www.diamondbackonline.com/news/mugging-on-mowatt-stairs-unsolved-1.1786266>

City officials to illuminate local streets

Police, city vow to tackle long-time lighting issues

November 16, 2010 by Leah Villanueva

<http://www.diamondbackonline.com/news/city-officials-to-illuminate-local-streets-1.1778318>

Police arrest two after backpack theft

Arrests occur within minutes of incident outside McKeldin Library

November 11, 2010 by Ben Present

<http://www.diamondbackonline.com/news/police-arrest-two-after-backpack-theft-1.1770504>

Police may employ cell phone videos to track crime

Professor creates app for crime victims, witnesses

November 5, 2010 by Ben Present

<http://www.diamondbackonline.com/news/police-may-employ-cell-phone-videos-to-track-crime-1.1748138>

Campus safety: A case of the blues

November 2, 2010 by Ellen Linzer

<http://www.diamondbackonline.com/opinion/campus-safety-a-case-of-the-blues-1.1739278>

Students harmed in three assaults

Police seek suspects in one of three incidents

November 1, 2010 by Ben Present

<http://www.diamondbackonline.com/news/students-harmed-in-three-assaults-1.1738304>

Guest column: A call for cameras

October 28, 2010 by Andre Beasley

<http://www.diamondbackonline.com/opinion/guest-column-a-call-for-cameras-1.1731987>

Police arrest third suspect in August robbery

Silver Spring man turned himself into police after arrest warrant was served

October 22, 2010 by Ben Present

<http://www.diamondbackonline.com/news/police-arrest-third-suspect-in-august-robbery-1.1722235>

Crimes worry Seven Springs residents

Robbery, attempted break-in around complex raise security concerns

October 20, 2010 by Ben Present

<http://www.diamondbackonline.com/crimes-worry-seven-springs-residents-1.1719305>

O'Malley promises to address city crime

Governor met with University Police officials to discuss campus security

October 15, 2010 by Kelly Farrell

<http://www.diamondbackonline.com/news/o-malley-promises-to-address-city-crime-1.1692091>

BREAKING: Police arrest suspect in stabbings

Kensington man charged with attempted murder, assault

October 13, 2010 by Ben Present and Lauren Redding

<http://www.diamondbackonline.com/news/breaking-police-arrest-suspect-in-stabbings-1.1687650>

In SGA walk, officials study where students feel least safe

Police say perceptions not indicative of danger

October 12, 2010 by Sarah Meehan

<http://www.diamondbackonline.com/news/in-sga-walk-officials-study-where-students-feel-least-safe-1.1678433>

Crime is down, police officials say

Students bombarded by crime alerts and newscasts decrying a College Park crime wave have reported feeling uneasy with the amount of criminal activity occurring on or near the campus this past month, but police officials said in reality, crime on the campus has gone down significantly.

October 5, 2010 by Ben Present

<http://www.diamondbackonline.com/news/crime-is-down-police-officials-say-1.1665169>

BREAKING: Man robbed behind Anne Arundel Hall

October 3, 2010 by Brady Holt

<http://www.diamondbackonline.com/news/breaking-man-robbed-behind-anne-arundel-hall-1.1661852>

Student falls victim to robbery on campus

Mugging incident took place outside Anne Arundel

October 3, 2010 by Amanda Pino

<http://www.diamondbackonline.com/news/student-falls-victim-to-robbery-on-campus-1.1662706>

Police install 19 cameras in Old Town

In addition to the 350 security cameras used to monitor activity on the campus, the city is installing 19 cameras in Old Town College Park in a move police officials hope will help mitigate crime and fear.

September 28, 2010 by Ben Present

<http://www.diamondbackonline.com/police-install-19-cameras-in-old-town-1.1651283>

Despite crime wave, students maintain their late-night habits

Rash of recent criminal activity in College Park makes some more wary, but many students remain unfazed

September 23, 2010 by Amanda Pino

<http://www.diamondbackonline.com/news/despite-crime-wave-students-maintain-their-late-night-habits-1.1645570>

REACHING OVER YELLOW TAPE

The new District 1 police commander wants students who have fallen victim to crime in College Park to know: He has felt their pain.

September 22, 2010 by Ben Present

<http://www.diamondbackonline.com/news/reaching-over-yellow-tape-1.1640356>

Man robbed, assaulted downtown

A group of three men assaulted and robbed a man in the parking lot of the College Park Shopping Center early yesterday morning, according to a crime alert.

September 20, 2010 by Kelly Farrell

<http://www.diamondbackonline.com/news/man-robbed-assaulted-downtown-1.1606611>

BREAKING: The search continues for bank robber

In what police officials have described as an unusually brash crime, the man brandished a gun, demanding the teller hand over cash. The bank worker complied and gave the suspect a money bag. Police officials declined to specify how much money was in the bag immediately following the incident

September 16, 2010 by LeylaKorkut and Marissa Lang

<http://www.diamondbackonline.com/news/breaking-the-search-continues-for-bank-robber-1.1602778>

Police warn students of ‘Crime Time’

Crime Time — Get Home Safely, a joint initiative by police and university organizations, has been in the works since the summer. Its message is simple: Between the hours of 2 and 4 a.m., students and residents of College Park are more likely to encounter crime.

September 9, 2010 by Ben Present

<http://www.diamondbackonline.com/news/police-warn-students-of-crime-time-1.1574503>

Four men robbed in two incidents just minutes apart

Near the campus marks an uptick in crime that District 1 Commander Maj. Robert Liberati said

September 8, 2010 by Ben Present

<http://www.diamondbackonline.com/news/four-men-robbed-in-two-incidents-just-minutes-apart-1.1572212>

Guest Column: A call for increased security

September 7, 2010 by Jeffrey Gunnarsson

<http://www.diamondbackonline.com/opinion/guest-column-a-call-for-increased-security-1.1554905>

Four men assault, rob student on Hartwick Rd.

A group of four men assaulted and robbed a student on Hartwick Road early Saturday, according to a crime alert.

September 7, 2010 by Ben Present

<http://www.diamondbackonline.com/news/four-men-assault-rob-student-on-hartwick-rd-1.1555502>

Staff Editorial: Pump up protection

University Police must expand their presence past Knox Road and Route 1 to other high-crime areas.

August 31, 2010 by Diamondback editorial board

<http://www.diamondbackonline.com/opinion/staff-editorial-pump-up-protection-1.1547530>

Groups of men rob students near campus

There were two groups of students robbed in College Park since Friday: Five men mugged three students waiting for a bus on Berwyn House Road at 1:34 a.m. yesterday, according to a crime alert from Prince George's County Police; in the Friday mugging, three students — all editors

August 29, 2010 by Leah Villanueva

<http://www.diamondbackonline.com/news/groups-of-men-rob-students-near-campus-1.1543323>

Gunmen pursue student on Route 1

After leaving hotel party, student and companion robbed of money, shoes by three men

August 12, 2010 by Leah Villanueva

<http://www.diamondbackonline.com/news/gunmen-pursue-student-on-route-1-1.1528417>

Students mugged in Lot 1

Two students were assaulted and robbed in Lot 1B on Friday afternoon, police said, and two 16-year-olds were arrested nearby shortly afterward in connection with the crime.

July 8, 2010 by Leah Villanueva

<http://www.diamondbackonline.com/news/students-mugged-in-lot-1-1.1497551>

Gunman robs student on College Ave.

Fourth mugging in two weeks is latest in series of crimes, including holdup at D.P. Dough

July 1, 2010 by Leah Villanueva

<http://www.diamondbackonline.com/gunman-robs-student-on-college-ave-1.1496067>

Student mugged at Leonardtown

Two women also robbed on Calvert Road on "Safe Corridor" to College Park Metro

June 24, 2010 by Richard Abdill

<http://www.diamondbackonline.com/news/student-mugged-at-leonardtown-1.1494569>

Robberies hit downtown, Courtyards

Man robbed at gunpoint near Metro station Wednesday night in latest of four incidents

June 3, 2010 by Richard Abdill and Maria Romas

<http://www.diamondbackonline.com/news/robberies-hit-downtown-courtyards-1.1488382>

Gunman robs student near University Courtyards

Masked man stole cell phone, wallet early Sunday

May 17, 2010 by Rich Abdill

<http://www.diamondbackonline.com/news/gunman-robs-student-near-university-courtyards-1.1482125>

Group tries to rob students by chapel

Police seek five or six men in attempted strong arm robbery early yesterday morning

May 10, 2010 by Ben Present

<http://www.diamondbackonline.com/news/group-tries-to-rob-students-by-chapel-1.1477535>

Spring crime wave hits the campus

A series of thefts swept across campus last month, with thieves making off with laptops, textbooks and electronic devices from offices, classrooms and residence halls, but police have not identified the source of the crime wave.

May 6, 2010 by Darren Botelho

<http://www.diamondbackonline.com/news/spring-crime-wave-hits-the-campus-1.1474607>

Armed robbers strike two city houses

Suspects were looking for drugs on Princeton Ave.; One had semi-automatic handgun

April 26, 2010 by Darren Botelho

<http://www.diamondbackonline.com/news/armed-robbers-strike-two-city-houses-1.1427608>

Multiple assailants beat man outside Santa Fe

Although a crime alert was sent out to the university community Friday concerning an assault at 4401 Knox Road, Prince George's County Police officials said yesterday that the incident actually occurred outside 4410 — Santa Fe Cafe.

April 20, 2010 by Darren Botelho

<http://www.diamondbackonline.com/news/multiple-assailants-beat-man-outside-santa-fe-1.1372946>

Man robbed, assaulted at city shopping center

A man unaffiliated with the university was robbed in the College Park Shopping Center on Sunday night after being threatened with a baseball bat by two men, a crime alert reported yesterday.

April 6, 2010 by Darren Botelho

<http://www.diamondbackonline.com/news/man-robbed-assaulted-at-city-shopping-center-1.1306545>

Three men rob student on Route 1

Fourth crime alert of the semester sent after possibly armed suspects steal cell phone

March 8, 2010 by Darren Botelho

<http://www.diamondbackonline.com/news/three-men-rob-student-on-route-1-1.1258643>

Three men rob student on South Campus

19-year-old North Campus resident was walking to study session in Harford Hall

February 25, 2010 by Darren Botelho

<http://www.diamondbackonline.com/news/three-men-rob-student-on-south-campus-1.1174827>

Council approves security cameras

In scaled-down plan, 15 surveillance cameras will be installed in downtown area

February 24, 2010 by Nick Rhodes

<http://www.diamondbackonline.com/news/council-approves-security-cameras-1.1171737>

Staff editorial: Safety school

University and city officials should make sure that the recent crime decrease was not a fluke.

February 17, 2010 by Diamondback editorial board

<http://www.diamondbackonline.com/opinion/staff-editorial-safety-school-1.1163338>

Three charged in South Campus Commons theft

February 5, 2010 by Darren Botelho

<http://www.diamondbackonline.com/news/three-charged-in-south-campus-commons-theft-1.1115620>

Prince George's crime levels hit 35-year low

Although burglaries remain a problem, crime in Prince George's County is the lowest it has been in 35 years, a milestone police officials chalk up to increased safety programs, more patrolling officers and a change in county strategy.

February 2, 2010 by Darren Botelho

<http://www.diamondbackonline.com/news/prince-george-s-crime-levels-hit-35-year-low-1.1110054>

More than 30 houses in the city burglarized over break

Fell victim to the crime wave.

January 28, 2010 by Darren Botelho

<http://www.diamondbackonline.com/news/more-than-30-houses-in-the-city-burglarized-over-break-1.1090427>

Burglaries over break alarm city landlords

Exact numbers unavailable, but association claims uptick

January 26, 2010 by Darren Botelho

<http://www.diamondbackonline.com/news/burglaries-over-break-alarm-city-landlords-1.1086319>

Holiday breaks see spikes in city burglaries

With students gone, empty houses and apartments make prime targets

December 1, 2009 by Amanda Pino

<http://www.diamondbackonline.com/news/holiday-breaks-see-spikes-in-city-burglaries-1.947752>

Burglaries serve as reminder of security problems

String ends after arrest, but unlocked doors, tailgating persist

November 24, 2009 by Kara Estelle

<http://www.diamondbackonline.com/news/burglaries-serve-as-reminder-of-security-problems-1.944896>

Police arrest student in Friday's stabbing

21-year-old charged with three counts of assault; lawyer says client is not guilty

November 10, 2009 by Kara Estelle

<http://www.diamondbackonline.com/news/police-arrest-student-in-friday-s-stabbing-1.892449>

Man stabbed on Hartwick Road

November 9, 2009 by Kara Estelle

<http://www.diamondbackonline.com/news/man-stabbed-on-hartwick-road-1.890958>

Student raped in off-campus house

Police searching for suspect; Crime occurred in the 7500 block of Dickinson Ave.

November 2, 2009 by Kara Estelle

<http://www.diamondbackonline.com/news/student-raped-in-off-campus-house-1.856073>

In District 1, public safety concerns dominate

Five candidates compete for two council seats in northern College Park

October 28, 2009 by Amanda Pino

<http://www.diamondbackonline.com/news/in-district-1-public-safety-concerns-dominate-1.832597>

Armed robber mugs female student Friday

Victim was getting off Shuttle-UM bus near Graduate Hills

October 26, 2009 by Kara Estelle

<http://www.diamondbackonline.com/news/armed-robber-mugs-female-student-friday-1.829217>

No students attend the SGA's annual safety walk

Campus tour catered to officials with the ability to make changes, officials say

October 21, 2009

<http://www.diamondbackonline.com/news/no-students-attend-the-sga-s-annual-safety-walk-1.794465>

Shootings' lasting impact unclear

Students, businesses unfazed despite bloody weekend

October 20, 2009 by Nick Rhodes

<http://www.diamondbackonline.com/news/shootings-lasting-impact-unclear-1.792917>

Man, 19, charged with assaulting student

Knox Road fight's direct cause unknown; student hospitalized with injuries

October 13, 2009 by Kara Estelle

<http://www.diamondbackonline.com/news/man-19-charged-with-assaulting-student-1.709731>

Univ. Police releases annual crime report

Some laud the report, saying it keeps students informed, safer

October 5, 2009 by Kara Estelle

<http://www.diamondbackonline.com/news/univ-police-releases-annual-crime-report-1.626959>

Police arrest 3 shortly after robbery

Fifteen minutes after crime, cameras used to track suspects to Knox Road CVS

October 1, 2009 by Nick Rhodes

<http://www.diamondbackonline.com/news/police-arrest-3-shortly-after-robbery-1.623824>

Student charged in reporting fake crime

Student had fabricated story of robbery, battery

October 1, 2009 by Nick Rhodes

<http://www.diamondbackonline.com/news/student-charged-in-reporting-fake-crime-1.623812>

Three men sought in armed robbery investigation

A student and an unaffiliated man were robbed at Knox Ave. and Princeton Ave. early Saturday

September 28, 2009 by Kara Estelle

<http://www.diamondbackonline.com/news/three-men-sought-in-armed-robbery-investigation-1.556135>

Police arrest four in connection with July robbery

University Police still searching for one suspect in July 31 robbery on the Mall

September 21, 2009 by Kara Estelle

<http://www.diamondbackonline.com/news/police-arrest-four-in-connection-with-july-robbery-1.524669>

Guest column: Shining a (blue) spotlight

September 15, 2009 by Andre Beasley

<http://www.diamondbackonline.com/opinion/guest-column-shining-a-blue-spotlight-1.475359>

Suspects identified in local crime string

September 10, 2009 by Kara Estelle

<http://www.diamondbackonline.com/news/suspects-identified-in-local-crime-string-1.437164>

Summer Crime Blotter

A roundup of all the crime over the summer in College Park

September 2, 2009 by Nick Rhodes

<http://www.diamondbackonline.com/news/summer-crime-blotter-1.348364>

Armed robber hits Route 1 liquor store

Employees were held at gunpoint; Crime alert is first of the semester

September 1, 2009 by Kara Estelle

<http://www.diamondbackonline.com/news/armed-robber-hits-route-1-liquor-store-1.348167>

One dead, one injured in city stabbing case

The city's second murder this year has no university connection. A domestic dispute ended with one man in the hospital and one dead. Police arrested Roberto Edmundo Cruz, 45, and charged him with second-degree murder in connection with the crime.

August 20, 2009 by Ben Slivnick

<http://www.diamondbackonline.com/news/one-dead-one-injured-in-city-stabbing-case-1.303353>

Man mugged on Knox and Princeton

21-year-old non-student, who lost wallet, other possessions, falls victim in early morning robbery.

August 20, 2009 by Rich Abdill

<http://www.diamondbackonline.com/news/man-mugged-on-knox-and-princeton-1.303354>

Despite drop in crime, students still feel unsafe

Although College Park crime rates continue to decline, students still have trouble feeling safe on and around the campus, a long-standing problem police say they aren't sure how to fix. "I'm terrified of Maryland's campus," sophomore letters and sciences major Michelle Vistica said.

May 14, 2009 by Nick Rhodes

<http://www.diamondbackonline.com/2.2795/despite-drop-in-crime-students-still-feel-unsafe-1.276851>

Guest Column: A concealed cause

The recent rash of crimes here in College Park has had me thinking about crime control. What ways are there to prevent crime? More police? That idea does have one drawback: money.

Police officers are expensive, and in this economy cost, is a crucial factor in any policymaking.

May 11, 2009 by Ryan Goff

<http://www.diamondbackonline.com/2.2792/guest-column-a-concealed-cause-1.276882>

Security camera details revealed

May 6, 2009 by Brady Holt

<http://www.diamondbackonline.com/2.2795/security-camera-details-revealed-1.276971>

Five men rob student outside Rt. 1 McDonald's

May 4, 2009 by Nick Rhodes

<http://www.diamondbackonline.com/2.2795/five-men-rob-student-outside-rt-1-mcdonald-s-1.277016>

Religious groups, police brainstorm new crimefighting tactics

University and community religious groups joined forces with university and county police yesterday to brainstorm ways of mitigating crime in College Park. Representatives from a broad range of university religious groups including Hindu, Muslim and Christian student organizations met

May 1, 2009 by James B. Hale

<http://www.diamondbackonline.com/2.2795/religious-groups-police-brainstorm-new-crimefighting-tactics-1.277046>

Student robbed in backyard

Armed robbery results in police sending out third crime alert in past week

April 29, 2009 by Adele Hampton

<http://www.diamondbackonline.com/2.2795/student-robbed-in-backyard-1.277098>

Four sought in strong-arm robbery

April 28, 2009 by Nick Rhodes

<http://www.diamondbackonline.com/2.2795/four-sought-in-strong-arm-robbery-1.277113>

Two people slashed near Route 1 bars

April 27, 2009 by Nick Rhodes

<http://www.diamondbackonline.com/2.2795/two-people-slashed-near-route-1-bars-1.277147>

A commander leaves home

During his time as the head of District 1, Davis saw College Park crime rates drop

April 15, 2009 by Nick Rhodes

<http://www.diamondbackonline.com/2.2795/a-commander-leaves-home-1.277356>

Safety: Not fixed with just a campus map

The safety map could actually make crime worse in College Park. It's one thing for students to talk about what parts of town are dangerous, but another entirely for a respected authority - in this case, the city's largest public institution, landowner and employer - to lay out where people should...

April 10, 2009 by Dan Reed

<http://www.diamondbackonline.com/2.2792/safety-not-fixed-with-just-a-campus-map-1.277417>

Crime: Get to the root of it - and green it up

Crime is always going to be high if you don't address poverty. The best way to reduce off-campus crime would be to revitalize the College Park community and make this area of Prince George's County better off. Easier said than done.

April 9, 2009 by Matt Dernoga

<http://www.diamondbackonline.com/2.2792/crime-get-to-the-root-of-it-and-green-it-up-1.277416>

Safety returns as major issue in SGA race

April 1, 2009 by Marissa Lang

<http://www.diamondbackonline.com/2.2795/safety-returns-as-major-issue-in-sga-race-1.277606>

Two men attack student, steal his property Friday

March 31, 2009 by Kyle Goon

<http://www.diamondbackonline.com/2.2795/two-men-attack-student-steal-his-property-friday-1.277631>

City funds security cameras in proposed budget

March 30, 2009 by Brady Holt

<http://www.diamondbackonline.com/2.2795/city-funds-security-cameras-in-proposed-budget-1.277659>

County police program to assess housing safety

March 12, 2009 by Nick Rhodes

<http://www.diamondbackonline.com/2.2795/county-police-program-to-assess-housing-safety-1.277866>

Man uses ladder to attempt second-floor Peeping Tom

March 10, 2009 by Kyle Goon

<http://www.diamondbackonline.com/2.2795/man-uses-ladder-to-attempt-second-floor-peeping-tom-1.277914>

Students foil robbery attempt

Police delay crime alert to pursue leads in case

March 4, 2009 by Nick Rhodes

<http://www.diamondbackonline.com/2.2795/students-foil-robbery-attempt-1.278011>

Suspects flee empty-handed in second robbery attempt in Feb.

February 23, 2009 by Nick Rhodes

<http://www.diamondbackonline.com/2.2795/suspects-flee-empty-handed-in-second-robbery-attempt-in-feb-1.278183>

Police tout improvements at safety forum

February 13, 2009 by Diana Elbasha

<http://www.diamondbackonline.com/2.2795/police-tout-improvements-at-safety-forum-1.278350>

Police honored for quick work

February 11, 2009 by Nick Rhodes

<http://www.diamondbackonline.com/2.2795/police-honored-for-quick-work-1.278399>

SGA aims to boost safety discussion at orientation

February 5, 2009 by Derby Cox

<http://www.diamondbackonline.com/2.2795/sga-aims-to-boost-safety-discussion-at-orientation-1.278507>

Fight witness almost robbed

individual, according to the student and a crime alert sent yesterday by University Police.

February 4, 2009 by Nick Rhodes

<http://www.diamondbackonline.com/2.2795/fight-witness-almost-robbed-1.278539>

Police arrest students for December robbery

One suspect already nabbed for Knox Road crime in January

February 4, 2009 by Kyle Goon

<http://www.diamondbackonline.com/2.2795/police-arrest-students-for-december-robbery-1.278531>

Police send out several robbery-related alerts during break

University Police released crime alerts for several local robberies during the holidays, up from three robbery alerts during winter break last year. University Police spokesman Paul Dillon said the fluctuation is fairly typical from year to year, and police have not noticed any significant rise

February 2, 2009 by Kyle Goon

<http://www.diamondbackonline.com/2.2795/police-send-out-several-robbery-related-alerts-during-break-1.278719>

Police arrest two in game store robbery

February 2, 2009 by Kyle Goon

<http://www.diamondbackonline.com/2.2795/police-arrest-two-in-game-store-robbery-1.278587>

Police arrest student for January robbery

January 28, 2009 by Kyle Goon

<http://www.diamondbackonline.com/2.2795/police-arrest-student-for-january-robbery-1.278661>

Student robbed at gunpoint in Univ. Park

January 26, 2009 by Nick Rhodes

<http://www.diamondbackonline.com/2.2795/student-robbed-at-gunpoint-in-univ-park-1.278715>

Crime spate hits University Square

Complex sees five robberies in six days in Nov.; grad students impacted

December 15, 2008 by Kyle Goon

<http://www.diamondbackonline.com/2.2795/crime-spate-hits-university-square-1.278772>

Researchers develop camera to analyze human movement

December 12, 2008 by Chris Yu

<http://www.diamondbackonline.com/2.2795/researchers-develop-camera-to-analyze-human-movement-1.278804>

Univ. crime rates continue to stay low

December 8, 2008 by Kyle Goon

<http://www.diamondbackonline.com/2.2795/univ-crime-rates-continue-to-stay-low-1.278913>

Police arrest two in September robbery

December 5, 2008 by Kyle Goon

<http://www.diamondbackonline.com/2.2795/police-arrest-two-in-september-robbery-1.278941>

Burglary increase sparks police outreach

December 3, 2008 by Kyle Goon

<http://www.diamondbackonline.com/2.2795/burglary-increase-sparks-police-outreach-1.278993>

Staff Editorial: More cops than robbers

November 16, 2008

<http://www.diamondbackonline.com/2.2792/staff-editorial-more-cops-than-robbers-1.279273>

Police surveillance: The state in nature

November 13, 2008 by Nathan Cohen

<http://www.diamondbackonline.com/2.2792/police-surveillance-the-state-in-nature-1.279327>

CRIME CARTOGRAPHY

University Police to plot crime locations on interactive map

November 11, 2008 by Kyle Goon

<http://www.diamondbackonline.com/2.2795/crime-cartography-1.279406>

Crime numbers beat average

November 10, 2008 by Kyle Goon

<http://www.diamondbackonline.com/2.2795/crime-numbers-beat-average-1.279437>

Two robbed in College Park over weekend

November 3, 2008 by Kyle Goon

<http://www.diamondbackonline.com/2.2795/two-robbed-in-college-park-over-weekend-1.279590>

Student fends off mugger Saturday

October 27, 2008 by Kyle Goon

<http://www.diamondbackonline.com/2.2795/student-fends-off-mugger-saturday-1.279730>

Community: Won't you be my neighbor?

October 24, 2008 by Vineeta Singh

<http://www.diamondbackonline.com/2.2792/community-won-t-you-be-my-neighbor-1.279737>

Police report decline in city crime

October 23, 2008 by Brady Holt

<http://www.diamondbackonline.com/2.2795/police-report-decline-in-city-crime-1.279786>

Police release photos of McKeldin masturbator

October 18, 2008 by Staff Reports

<http://www.diamondbackonline.com/2.2795/police-release-photos-of-mckeldin-masturbator-1.279900>

Robbers shove student bicyclist

October 9, 2008 by Kyle Goon

<http://www.diamondbackonline.com/2.2795/robbers-shove-student-bicyclist-1.280051>

Security concerns emerge after Leonardtown robbery

September 30, 2008 by Kyle Goon

<http://www.diamondbackonline.com/2.2795/security-concerns-emerge-after-leonardtown-robbery-1.280254>

Burglar enters three College Park Towers apartments

September 26, 2008 by Kyle Goon

<http://www.diamondbackonline.com/2.2795/burglar-enters-three-college-park-towers-apartments-1.280310>

Three men force their way into apartment

September 26, 2008 by Kyle Goon

<http://www.diamondbackonline.com/2.2795/three-men-force-their-way-into-apartment-1.280305>

Student mugged on her front doorstep

September 18, 2008 by Kyle Goon

<http://www.diamondbackonline.com/2.2795/student-mugged-on-her-front-doorstep-1.280479>

Leaders: Protect students from crime, not themselves

Crime is like that annoying friend from your freshman dorm - it shows up at inopportune times and it attacks before you have time to react. But instead of awkward exchanges of "Let's hang out sometime," you could be knocked down with your wallet stolen.

September 16, 2008 by Joel Cohen

<http://www.diamondbackonline.com/2.2792/leaders-protect-students-from-crime-not-themselves-1.280488>

Victim says robber hit him over the head

Student said he did not report the crime because 'there's no real point'

September 15, 2008 by Kyle Goon

<http://www.diamondbackonline.com/2.2795/victim-says-robber-hit-him-over-the-head-1.280553>

A sure bet for more crime and commotion

September 15, 2008 by Sara Ackerman

<http://www.diamondbackonline.com/2.2792/a-sure-bet-for-more-crime-and-commotion-1.280516>

Student mugged on Fraternity Row field

September 8, 2008 by Kyle Goon

<http://www.diamondbackonline.com/2.2795/student-mugged-on-fraternity-row-field-1.280678>

Summer car thefts, burglaries increase

Police spokesman Paul Dillon remembers how summer crime went in College Park 20 years ago. "Ghost town," he said. "There was hardly anything going on at all." Nowadays, the university is more active year-round and has more programs during the summer months.

September 4, 2008

<http://www.diamondbackonline.com/2.2795/summer-car-thefts-burglaries-increase-1.280731>

Crime reported too late to send text alert, police say

University Police did not send a text message alerting the campus community to an attempted kidnapping Aug. 13 because the victim reported the crime 14 hours after the incident. Police distributed an e-mail crime alert for the incident, but Dillon said the victim reported it too slowly

August 20, 2008 by Brady Holt

<http://www.diamondbackonline.com/2.2795/crime-reported-too-late-to-send-text-alert-police-say-1.280818>

A backyard view

We are all accustomed to the university making the news. Every time a remotely newsworthy event happens on the campus, regional and sometimes national media descend on the campus with their satellite trucks and attractive reporters faster than it takes to read the crime alert e-mail.

August 20, 2008 by Joel Cohen

<http://www.diamondbackonline.com/2.2792/a-backyard-view-1.280801>

BREAKING NEWS: Man attacks student in possible kidnapping attempt

Man attacks student in Lot 1 Wednesday night; University Police send e-mail crime alert

August 14, 2008 by Brady Holt

<http://www.diamondbackonline.com/2.2795/breaking-news-man-attacks-student-in-possible-kidnapping-attempt-1.280841>

String of break-ins hit campus parking lots

August 2, 2008 by Brady Holt

<http://www.diamondbackonline.com/2.2795/string-of-break-ins-hit-campus-parking-lots-1.280883>

No crime alerts sent in five weeks

July 9, 2008 by Brady Holt

<http://www.diamondbackonline.com/2.2795/no-crime-alerts-sent-in-five-weeks-1.280974>

Staff Editorial: Cause for alarm

July 2, 2008

<http://www.diamondbackonline.com/2.2792/staff-editorial-cause-for-alarm-1.280958>

Pair of crimes hits Grad Hills

approached by two men, according to a crime report sent out by University Police.

June 5, 2008 by Brady Holt

<http://www.diamondbackonline.com/2.2795/pair-of-crimes-hits-grad-hills-1.281081>

Female student victim of Peeping Tom

June 4, 2008 by Brady Holt

<http://www.diamondbackonline.com/2.2795/female-student-victim-of-peeping-tom-1.281080>

Staff Editorial: Crime-free what?

Our View: The university should explain what a crime-free zone is to make such a goal meaningful and achievable.

May 8, 2008 by The Editorial Staff

<http://www.diamondbackonline.com/2.2792/staff-editorial-crime-free-what-1.281187>

Senate urges safety reforms

April 30, 2008 by Kevin Robillard

<http://www.diamondbackonline.com/2.2795/senate-urges-safety-reforms-1.281384>

Man mugged outside CVS

April 28, 2008 by Ben Worsley

<http://www.diamondbackonline.com/2.2795/man-mugged-outside-cvs-1.281443>

Police obtain picture of one on-campus robbery suspect

April 18, 2008 by Ben Worsley

<http://www.diamondbackonline.com/2.2795/police-obtain-picture-of-one-on-campus-robbery-suspect-1.281601>

Police see sharp rise in threat reporting

April 16, 2008 by Kellie Woodhouse and Ben Worsley

<http://www.diamondbackonline.com/2.2795/police-see-sharp-rise-in-threat-reporting-1.281656>

Student robbed near English bldg.

April 14, 2008 by Ben Worsley

<http://www.diamondbackonline.com/2.2795/student-robbed-near-english-bldg-1.281712>

Spending for safety

April 8, 2008 by The Editorial Staff

<http://www.diamondbackonline.com/2.2792/spending-for-safety-1.281767>

Woman robbed near Metro

A woman was robbed at gunpoint and had her purse stolen shortly after getting off work Saturday night near Hartwick Road and Yale Avenue, according to police. According to a crime alert issued to the university community, the incident occurred at about 11:30 p.m.

March 31, 2008 by Ben Worsley

<http://www.diamondbackonline.com/2.2795/woman-robbed-near-metro-1.281984>

2nd suspect arrested in assault, robbery

March 27, 2008 by Ben Worsley

<http://www.diamondbackonline.com/2.2795/2nd-suspect-arrested-in-assault-robbery-1.282039>

Two robbed in Knox Road incident

March 27, 2008 by Ben Worsley

<http://www.diamondbackonline.com/2.2795/two-robbed-in-knox-road-incident-1.282038>

Masked men rob 7-Eleven on Knox Road

March 24, 2008 by Ben Worsley

<http://www.diamondbackonline.com/2.2795/masked-men-rob-7-eleven-on-knox-road-1.282113>

Man arrested, charged in attempted robbery

March 7, 2008 by Ben Worsley

<http://www.diamondbackonline.com/2.2795/man-arrested-charged-in-attempted-robbery-1.282308>

Guest Column: Assault is not cuddly

March 6, 2008 by Lauren Nielsen

<http://www.diamondbackonline.com/2.2792/guest-column-assault-is-not-cuddly-1.282281>

Masked crew attempts robbery on Princeton

March 5, 2008 by Ben Worsley

<http://www.diamondbackonline.com/2.2795/masked-crew-attempts-robbery-on-princeton-1.282357>

City 'cuddler' assaults two women

March 4, 2008 by Kellie Woodhouse

<http://www.diamondbackonline.com/2.2795/city-cuddler-assaults-two-women-1.282385>

BREAKING: Olde Town 'cuddler' assaults two women

March 3, 2008 by Kevin Litten

<http://www.diamondbackonline.com/2.2795/breaking-olde-town-cuddler-assaults-two-women-1.282417>

Staff Editorial: Policing the presence

Our View: The city must focus funding on increasing police presence in order to keep students safe in College Park.

March 3, 2008 by Staff Editorial

<http://www.diamondbackonline.com/2.2792/staff-editorial-policing-the-presence-1.282366>

POLICE INVESTIGATING HOMICIDE AT UNIV. TOWN CENTER

March 2, 2008 by Kevin Litten

<http://www.diamondbackonline.com/2.2795/police-investigating-homicide-at-univ-town-center-1.282444>

Student robbed of cell phone, wallet

February 29, 2008 by Ben Worsley

<http://www.diamondbackonline.com/2.2795/student-robbed-of-cell-phone-wallet-1.282439>

Police investigating murder of College Park man

February 26, 2008 by Ben Worsley

<http://www.diamondbackonline.com/2.2795/police-investigating-murder-of-college-park-man-1.282520>

Two men try to rob student on Fraternity Row

Incident occurred outside Kappa Alpha order house; crime apparently stemmed from earlier disagreement at Santa Fe

February 25, 2008 by Ben Worsley

<http://www.diamondbackonline.com/2.2795/two-men-try-to-rob-student-on-fraternity-row-1.282552>

Police seek two men in stabbing

Police acknowledged yesterday that it remains unclear who wielded a knife in the stabbing of a Terps football player over the weekend, but said charges brought against a student on Tuesday were appropriate because of his alleged role in the crime. Prince George's County Police District 1 commander...

February 22, 2008 by Ben Worsley

<http://www.diamondbackonline.com/2.2795/police-seek-two-men-in-stabbing-1.282575>

Thieves target textbooks, electronics in crime uptick

February 22, 2008 by Chris Yu

<http://www.diamondbackonline.com/2.2795/thieves-target-textbooks-electronics-in-crime-uptick-1.282579>

Robbers in Berwyn target two women

February 22, 2008 by Cassie Bottge

<http://www.diamondbackonline.com/2.2795/robbers-in-berwyn-target-two-women-1.282576>

Victim, others dispute stabbing charges

February 21, 2008 by Ben Worsley

<http://www.diamondbackonline.com/2.2795/victim-others-dispute-stabbing-charges-1.282609>

Sophomore arrested in player's stabbing

February 20, 2008 by Ben Worsley

<http://www.diamondbackonline.com/2.2795/sophomore-arrested-in-player-s-stabbing-1.282635>

University urges text signups after recent campus shootings

February 18, 2008 by Ben Worsley

<http://www.diamondbackonline.com/2.2795/university-urges-text-signups-after-recent-campus-shootings-1.282694>

Teen injured in shooting near Univ. Town Center

February 14, 2008 by Ben Worsley

<http://www.diamondbackonline.com/2.2795/teen-injured-in-shooting-near-univ-town-center-1.282777>

Nearly 7 years after carjacking, U. Police make arrest

February 8, 2008 by Ben Worsley

<http://www.diamondbackonline.com/2.2795/nearly-7-years-after-carjacking-u-police-make-arrest-1.282858>

Thieves targeting cars with GPS

February 6, 2008 by Ben Worsley

<http://www.diamondbackonline.com/2.2795/thieves-targeting-cars-with-gps-1.282904>

Break-ins spur more vigilance, police say

January 30, 2008

<http://www.diamondbackonline.com/2.2795/break-ins-spur-more-vigilance-police-say-1.283033>

Burglary spree hits 20 student residences

January 28, 2008 by Steven Overly

<http://www.diamondbackonline.com/2.2795/burglary-sprees-hits-20-student-residences-1.283096>

On-campus crime falls to 10-year low mark

January 25, 2008 by Steve Overly

<http://www.diamondbackonline.com/2.2795/on-campus-crime-falls-to-10-year-low-mark->

1.283146

Appendix G: Maps of College Park

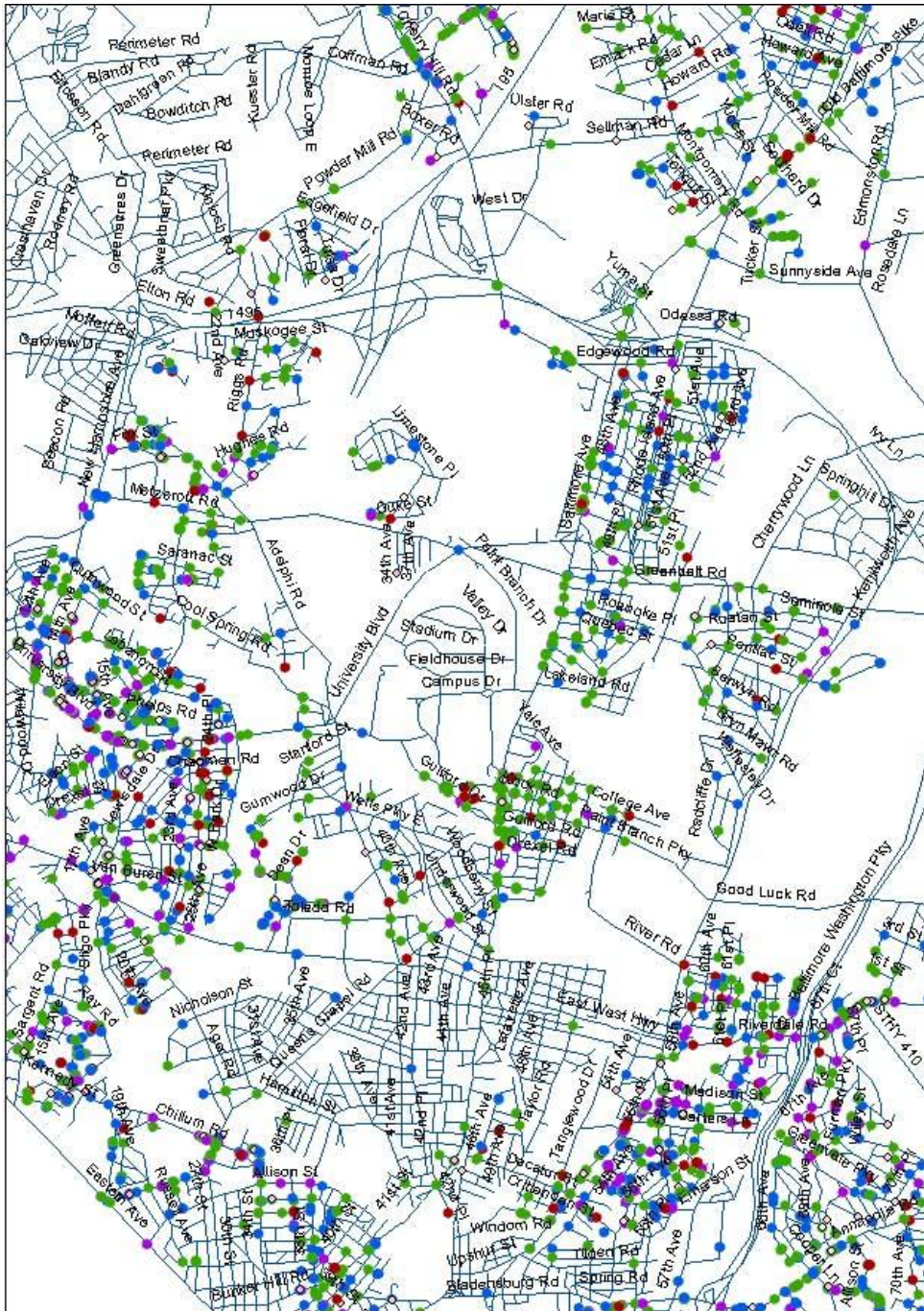

Figure 13: A crime-density map made in ArcGIS with crime data provided by the Prince George's County Police Department. Green dots represent larcenies, red dots represent burglaries, purple dots represent robberies and blue dots represent motor vehicle thefts.

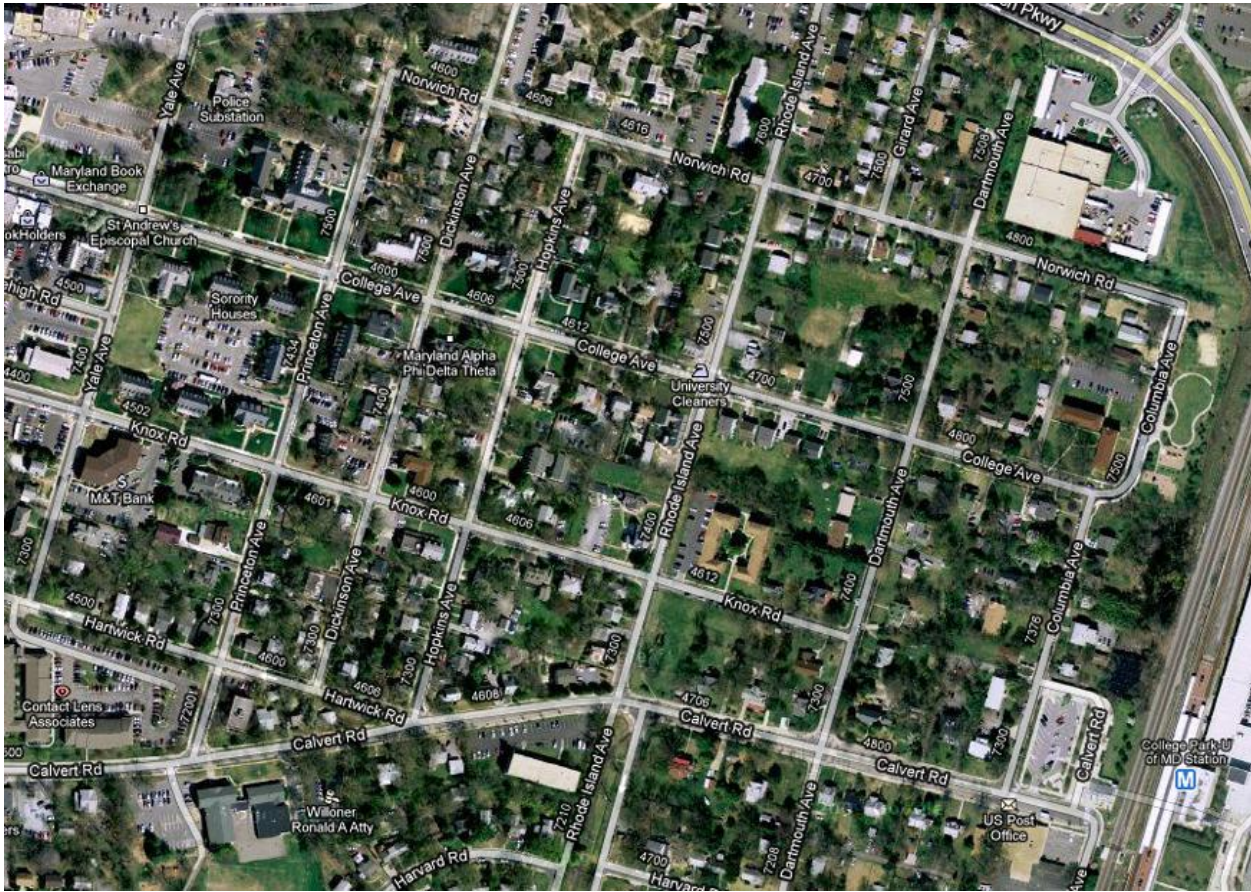

Figure 14: An overhead view of the Old Town neighborhood in College Park. Image provided by Google Maps (<http://maps.google.com>).



Figure 15: Property boundaries and building locations in the Old Town neighborhood of College Park as of 2006. Image created by the Maryland-National Capital Park & Planning Commission. Grey shapes indicate contributing (historical) resources, green shapes indicate non-contributing (non-historical) resources, and shapes with a faint outline indicate buildings outside the historical district of interest.



Figure 16: A CPTED-adherence map of the Old Town neighborhood of College Park, created by Team CP² with CPTED data gathered between March 2009 and October 2010.

Appendix H: Crime Prevention through Environmental Design (CPTED) Training

The research team received two days of training in Crime Prevention through Environmental Design (CPTED) theory and strategies from Dr. Diane Zahm, associate chair and associate professor of urban affairs and planning at the Virginia Polytechnic Institute and University. On the first day, the training began in the classroom with an overview of basic CPTED concepts and broad tactics for implementation. Interactive exercises allowed the team to understand and use such concepts and tactics through practice. The first day of training also explored how these theoretical concepts and tactics could be applied in residential neighborhoods, how to complete neighborhood CPTED evaluations, the relationship between crime and the environment, the relationship between lighting and crime, potential CPTED project options, and how to evaluate a CPTED project. The second day of training took place outside the classroom. The team explored residential areas around the University of Maryland campus, led Dr. Zahm, and gained further understanding of the concepts and tactics learned on the first day of training by seeing how they could be applied to the neighborhoods around campus.

Appendix I: List of Acronyms

ALPR = Automated License Plate Recognition [Camera]

CCTV = Closed Circuit Television

CPTED = Crime Prevention through Environmental Design

FBI = Federal Bureau of Investigation

GIS = Geographic (Geospatial) Information System

IRB = Institutional Review Board

PERT = Public Emergency Response Telephones

PGCPD = Prince George's County Police Department

POP = Problem Oriented Policing

SARA = Scanning Analysis Response Assessment

SOC = Security Operations Center

SPSS = Statistical Package for the Social Sciences

UCR = Unified Crime Reporting

UMD = University of Maryland, College Park

Appendix J: Technical Specifications for the Spectra IV IP Series Network Dome System

Camera/Optics

	Day/Night (35X)	Day/Night (27X)	Day/Night (23X)
Signal Format	NTSC (DD4CBW35) PAL (DD4CBW35-X)	NTSC (DD427) PAL (DD427-X)	NTSC (DD423) PAL (DD423-X)
Scanning System	Interface/Progressive selectable	Interlace/Progressive selectable	2:1 Interlace
Image Sensor	1/4-inch EXview HAD™	1/4-inch EXview HAD	1/4-inch EXview HAD
Effective Pixels			
NTSC	768 (H) X 494 (V)	768 (H) X 494 (V)	768 (H) X 494 (V)
PAL	752 (H) X 582 (V)	752 (H) X 582 (V)	752 (H) X 582 (V)
Horizontal Resolution			
NTSC	>540 TV Lines	>540 TV Lines	540 TV Lines
PAL	>540 TV Lines	>540 TV Lines	540 TV Lines
Lens	f/1.4 (focal length, 3.4–119 mm)	f/1.4 (focal length, 3.4–91.8 mm)	f/1.6 (focal length, 3.6–82.8 mm)
Zoom	35X optical, 12X digital	27X optical, 12X digital	23X optical, 12X digital
Zoom Speed (optical range)	3.2/4.6/6.6 seconds	3.2/4.6/6.6 seconds	2.9/4.2/5.8 seconds
Horizontal Angle of view	55.8° at 3.4 mm wide zoom; 1.7° at 119 mm telephoto zoom	55.8° at 3.4 mm wide zoom; 2.3° at 91.8 mm telephoto zoom	54° at 3.6 mm wide zoom; 2.5° at 82.8 mm telephoto zoom
Focus	Automatic with manual override	Automatic with manual override	Automatic with manual override
Maximum Sensitivity at 35 IRE NTSC/EIA	0.55 lux at 1/60 sec (color) 0.018 lux at 1/2 sec (color) 0.00018 lux at 1/2 sec (B-W)	0.55 lux at 1/60 sec (color) 0.018 lux at 1/2 sec (color) 0.00018 lux at 1/2 sec (B-W)	0.65 lux at 1/60 sec (color) 0.15 lux at 1/60 sec (B-W)
PAL/CCIR	0.45 lux at 1/50 sec (color) 0.015 lux at 1/1.5 sec (color) 0.00015 lux at 1/1.5 sec (B-W)	0.45 lux at 1/50 sec (color) 0.015 lux at 1/1.5 sec (color) 0.00015 lux at 1/1.5 sec (B-W)	0.55 lux at 1/50 sec (color) 0.12 lux at 1/50 sec (B-W)
Sync System	Internal/AC line lock, phase adjustable using remote control, V-Sync	Internal/AC line lock, phase adjustable using remote control, V-Sync	Internal/AC line lock, phase adjustable using remote control, V-Sync
White Balance	Automatic with manual override	Automatic with manual override	Automatic with manual override
Shutter Speed	Automatic (electronic iris)/Manual 1/2 –1/30,000	Automatic (electronic iris)/Manual 1/2 –1/30,000	Automatic (electronic iris)/Manual 1/2 –1/30,000
NTSC			
PAL	1/1.5 –1/30,000	1/1.5 –1/30,000	1/1.5 –1/30,000
Iris Control	Automatic iris control with manual override	Automatic iris control with manual override	Automatic iris control with manual override
Gain Control	Automatic/OFF	Automatic/OFF	Automatic/OFF
Video Output	1 Vp-p, 75 ohms	1 Vp-p, 75 ohms	1 Vp-p, 75 ohms
Video Signal-to-Noise	>50 dB	>50 dB	>50 dB
Wide Dynamic Range	128X	128X	—
Electronic Image Stabilization	Integrated/Selectable	—	—
Image Enhancement	Integrated/Selectable	—	—
Video Motion Detection	Integrated	Integrated	—

Video

Analog	NTSC/PAL
Digital Compression	MJPEG, MPEG-4 (available only with Microsoft® Internet Explorer®)
Video Streams	3, simultaneous
Video Resolutions	NTSC PAL
4CIF	704 x 480 704 x 576
2CIF	704 x 240 704 x 288
CIF	352 x 240 352 x 288
QCIF	176 x 120 176 x 144
Bit Rate Configurable	
MPEG-4	30 ips, 2 Mbps for primary stream, 1 Mbps for secondary stream; implements EnduraView
MJPEG	15 ips, 3 Mbps, MJPEG
Web User Interface	Pelco Device Utility interface for viewing HTTP, requires Java Runtime Environment (JRE™)
Users	5 simultaneous users MJPEG and/or MPEG-4 unicast; unlimited number of users using multicast (MPEG-4 only)
Minimum System Requirements	
Processor	Intel® Pentium® 4 microprocessor, 1.6 GHz
Operating System	Windows® 98, Windows 2000, Windows XP (or later), or Mac® OS X 10.3.9 (or later)
Memory	512 MB RAM
Network Interface Card	100 megabits
Web Browser	Internet Explorer 5.5 (or later); Mozilla® Firefox® 1.5 (or later)
Monitor	Minimum of 1024 x 768 resolution, 16- or 32-bit pixel color resolution
Firmware Upgrade	Pelco Device Utility or Endura Application
Supported Protocols	TCP/IP, UDP/IP (unicast, multicast IGMP), UPnP, DNS, DHCP, RTP, NTP

Dome Drive Features

35X and 27X Models

- 256 Presets
- $\pm 0.1^\circ$ Preset Accuracy
- Electronic Image Stabilization (35X model)
- Image Enhancement (35X model)
- Multilingual Menus (English, Spanish, Portuguese, Italian, French, German, Russian, Polish, Turkish, and Czech)
- RJ-45 Data Port for Software Update and Setup
- On-Screen Compass, Tilt, and Zoom Display
- Password Protection
- 400°/sec Pan Preset Speed and 200°/sec Tilt Preset Speed
- Rotating Discreet Liner with Sealed Fixed Bubble
- Window Blanking: Up to 8, Four-Sided, User-Defined Shapes
- 8 Zones (configurable in size) Can Be Labeled with up to 20 Characters Each or Set to Output Blank Video
- 7 Alarm Inputs
- 1 Auxiliary (Form C) Relay Output and 1 Open Collector Auxiliary Output (can be alternately programmed to operate upon alarm)
- Configurable Locations of Labels and On-Screen Displays
- Action on Alarm: Alarms Can Be Individually Programmed for 3 Priority Levels, to Initiate a Stored Pattern, or to Go to an Associated Preset When Received
- Resume After Alarm: Allows the Dome to Return to a Previously Programmed State After Alarm Acknowledgement or to its Previous Position Before Alarm
- Multiple Park and Power-Up Action
- Patterns: Up to 8, On-Screen, User-Defined Configurable Patterns; Includes Pan, Tilt, Zoom, and Preset Functions
- Proportional Pan/Tilt: Continually Decreases Pan/Tilt Speeds in Proportion to Depth of Zoom
- Variable Scan Speed: Scan Speed Can Be Configurable Between 1-40°/sec
- Pan Motion Allows 0.1° to 150°/sec Pan Speed
- Configurable Limit Stops for Auto/Random/Frame Scan Modes
- Autosensing Protocol (Coaxitron®, RS-422 Pelco P and Pelco D, Sensomatic®, Vicon®); Accepts Other Control Protocols with Optional Translator Card
- Digital Position and Zoom Control and Feedback Through Pelco D Protocol
- Built-in Menu System for Setup of Configurable Functions
- "Auto Flip" Rotates Dome 180° at Bottom of Tilt Travel
- Configurable Zoom Speeds
- Freeze Frame During Presets

23X Models

- 64 Presets
- $\pm 0.1^\circ$ Preset Accuracy
- Multilingual Menus (English, Spanish, Portuguese, Italian, French, German, Russian, Polish, Turkish, and Czech)
- RJ-45 Data Port for Software Update and Setup
- On-Screen Compass, Tilt, and Zoom Display
- Password Protection
- 400°/sec Pan Preset Speed and 200°/sec Tilt Preset Speed
- Rotating Discreet Liner with Sealed Fixed Bubble
- Window Blanking: Up to 4, Four-Sided, User-Defined Shapes
- 8 Zones (configurable in size) Can Be Labeled with up to 20 Characters Each or Set to Output Blank Video
- 1 Alarm Input
- 1 Auxiliary (Form C) Relay Output
- Configurable Locations of Labels and On-Screen Displays
- Patterns: 1 On-Screen, User-Defined Configurable Pattern; Includes Pan, Tilt, Zoom, and Preset Functions
- Proportional Pan/Tilt: Continually Decreases Pan/Tilt Speeds in Proportion to Depth of Zoom
- Variable Scan Speed: Scan Speed Can Be Configurable Between 1-40°/sec
- Pan Motion Allows 0.1° to 150°/sec Pan Speed
- Autosensing Protocol (Coaxitron, RS-422 Pelco P and Pelco D, Sensomatic, Vicon); Accepts Other Control Protocols with Optional Translator Card
- Digital Position and Zoom Control and Feedback through Pelco D Protocol
- Built-in Menu System for Setup of Configurable Functions
- "Auto Flip" Rotates Dome 180° at Bottom of Tilt Travel
- Freeze Frame During Presets

Back Box Features

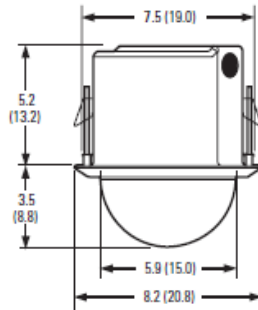

In-Ceiling (Indoor)

- Built-in Memory Stores Camera/Dome Settings
- Single Back Box for Suspended or Hard Ceiling Applications
- Requires 5.25-Inch Space Above Ceiling and 3.25 Inches Below
- Minimum Ceiling Thickness 0.5-Inch; Maximum 1.75 Inches
- Quick Disconnect to Dome Drive
- Aluminum Construction
- Suitable for Use in Environmental Air Handling Spaces



(ENVIRONMENTAL DOME WITH SUN SHROUD SHOWN)

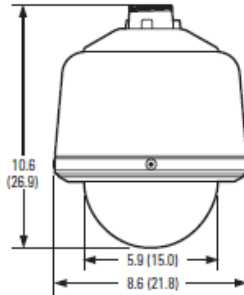

Standard and Environmental Pendant

- Standard and Environmental Models
- Built-in Memory Stores Camera/Dome Settings
- Standard Pendant Available in Black or Gray Finish; Environmental Pendant Gray Finish Only
- Quick Disconnect to Dome Drive
- Aluminum Construction
- Environmental Model Includes Sun Shield, Fan, and Heater

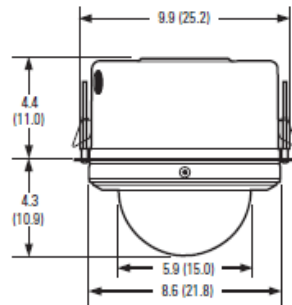

NOTE: VALUES IN PARENTHESES ARE CENTIMETERS; ALL OTHERS ARE INCHES.

Environmental In-Ceiling

- Built-in Memory Stores Camera/Dome Settings
- Single Back Box for Hard Ceiling Applications
- Requires 4.4-Inch Space Above Ceiling and 4.3 Inches Below
- Includes Heater and Fan
- Minimum Ceiling Thickness 0.5-Inch; Maximum 1.75 Inches
- Quick Disconnect to Dome Drive
- Aluminum Construction

Back Box Features Continued

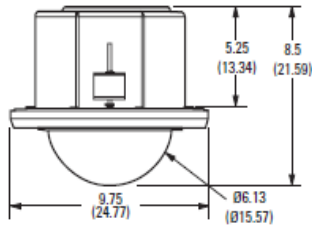

Heavy-Duty In-Ceiling (Indoor)

Available only with 27X and 35X models

- Built-in Memory Stores Camera/Dome Settings
- Single Back Box for Hard Ceiling Applications
- Requires 5.25-Inch Space Above Ceiling and 3.25 Inches Below
- Quick Disconnect to Dome Drive
- Reinforced Mounting System
- Heavy-Duty Polycarbonate Dome Bubble
- Aluminum Trim Ring with Barrel-Type Key Locks
- Optional Protective Cage

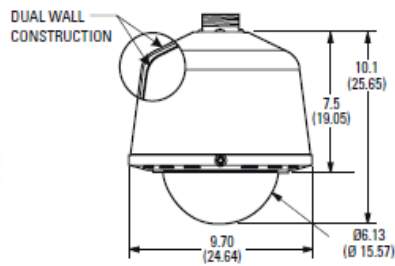

Heavy-Duty Pendant

Available only with 27X and 35X models

- Standard and Environmental Models
- Built-in Memory Stores Camera/Dome Settings
- Quick Disconnect to Dome Drive
- Dual Wall Construction
- Heavy-Duty Polycarbonate Dome Bubble
- Aluminum Trim Ring with Barrel-Type Key Locks
- Optional Protective Cage
- Environmental Model Includes Sun Shield, Fan, and Heater

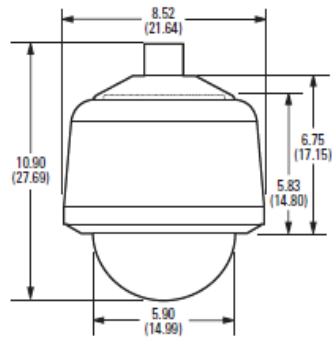

NOTE: VALUES IN PARENTHESES ARE CENTIMETERS; ALL OTHERS ARE INCHES.

Stainless Steel Pendant

Available only with 27X and 35X models

- Standard and Environmental Models
- Built-in Memory Stores Camera/Dome Settings
- Quick Disconnect to Dome Drive
- All Stainless Steel Construction
- Includes Sun Shield, Fan, and Heater

Technical Specifications – Overview

GENERAL

Construction	
Back Box	
In-Ceiling	Aluminum
Pendant	Aluminum
Heavy-Duty	Aluminum
Stainless Steel	316 stainless steel; gray, polyurethane powder coated finish
Dome Drive	
Lower Dome	
In-Ceiling	Acrylic
Pendant	Acrylic
Heavy-Duty	Polycarbonate, 0.09-inch thick
Stainless Steel	Acrylic
Light Attenuation	
Smoked	f/0.5 light loss
Clear	Zero light loss
Chrome	f/2.0 light loss
Gold	f/2.0 light loss
Cable Entry (back box)	
In-Ceiling	0.75-inch conduit fitting
Pendant	Through 1.5-inch NPT pendant mount
Weight (approximate)	
	Unit Shipping
In-Ceiling	5.2 lb (2.4 kg) 8 lb (3.6 kg)
Environmental In-Ceiling	6.2 lb (2.8 kg) 10 lb (4.5 kg)
Standard Pendant	6.5 lb (3.0 kg) 11 lb (5.0 kg)
Environmental Pendant	7.6 lb (3.5 kg) 12 lb (5.4 kg)
Heavy-Duty In-Ceiling*	7.3 lb (3.3 kg) 12 lb (5.4 kg)
Heavy-Duty Pendant*	9.8 lb (4.5 kg) 16 lb (7.3 kg)
Heavy-Duty Environmental Pendant*	9.8 lb (4.5 kg) 16 lb (7.3 kg)
Stainless Steel	10.1 lb (4.6 kg) 16 lb (7.3 kg)
Environment	
In-Ceiling	Indoor
Environmental In-Ceiling	Outdoor
Pendant, Standard and	
Environmental	Indoor/outdoor
Heavy-Duty In-Ceiling	Indoor
Heavy-Duty Pendant,	
Standard & Environmental	Indoor/outdoor
Stainless Steel	Indoor/outdoor
Operating Temperature	
In-Ceiling	32° to 122°F (0° to 50°C)
Standard Pendant	(Assumes no wind chill factor)
Maximum	113°F (45°C) absolute maximum; 95°F (35°C) sustained maximum
Minimum	25°F (-4°C) sustained minimum
Environmental In-Ceiling	
and Environmental Pendant	(Assumes no wind chill factor)
Maximum	140°F (60°C) absolute maximum; 122°F (50°C) sustained maximum
Minimum	-60°F (-51°C) absolute minimum; prevents icing at sustained minimum of -50°F (-45°C); de-ices 0.1 inch (2.5 mm) within 3 hours after power-up
Heavy-Duty In-Ceiling	32° to 122°F (0° to 50°C)
Heavy-Duty Pendant	32° to 122°F (0° to 50°C) absolute maximum; 32° to 122°F (0° to 50°C) sustained maximum
Heavy-Duty	
Environmental Pendant	(Assumes no wind chill factor)
Maximum	140°F (60°C) absolute maximum; 122°F (50°C) sustained maximum
Minimum	-60°F (-51°C) absolute minimum; minimal icing at sustained minimum of -50°F (-45°C); prevents icing at sustained minimum of -40°F (-40°C); de-ices 0.1 inch (2.5 mm) within 3 hours after power-up

Stainless Steel	(Assumes no wind chill factor)
Maximum	140°F (60°C) absolute maximum; 122°F (50°C) sustained maximum
Minimum	-60°F (-51°C) absolute minimum; minimal icing at sustained minimum of -50°F (-45°C); prevents icing at sustained minimum of -40°F (-40°C); de-ices 0.1 inch (2.5 mm) within 3 hours after power-up
Effective Projected Area (EPA)	20.5 square inches (without mount) 47 square inches (with IWM Series mount)

MECHANICAL

(Dome Drive Only)

Pan Movement	360° continuous pan rotation
Vertical Tilt	Unobstructed +2° to -92°
Manual Pan/Tilt Speeds	
Pan	0.1° to 80°/sec manual operation, 150°/sec Turbo
Tilt	0.1° to 40°/sec manual operation
Preset Speeds	
Pan	400°/sec
Tilt	200°/sec
	For variable-speed operation, an appropriate controller is required. (With nonvariable speed control, Spectra IV IP pan/tilt speed is 20°/sec)

AUDIO

Streaming	Bidirectional: full or half duplex
Input/Output	Terminal block, analog for microphone and speaker; 600-ohm differential; 1 Vp-p maximum signal level
Compression	G.711 PCM 8 bit, 8 kHz mono at 64 kbit/s

ELECTRICAL

Ports	RJ-45 connector for 100Base-TX Auto MDI/MDI-X Autonegotiate/Manual setting
Cabling Type	Cat5 or better for 100Base-TX
Input Voltage	18 to 32 VAC; 24 VAC nominal 22 to 27 VDC; 24 VDC nominal
Input Power	
24 VAC	23 VA nominal (without heater); 73 VA nominal (with heater)
24 VDC	0.7 A nominal (without heater); 3 A nominal (with heater)
Fuse	1.25 A
Auxiliary Outputs	2
Alarm Inputs	7

CERTIFICATIONS/RATINGS/PATENTS

- CE, Class B
 - FCC, Class B
 - UL/cUL Listed
 - C-Tick
 - U.S. Patents 5,931,432; 6,793,415 B2; 6,802,656 B2; 6,821,222 B2; 7,161,615 B2
- Meets the following standards:
- NEMA Type 4X, IP66 when installed properly (BB4N-F-E, BB4N-PB, BB4N-PG, BB4N-PG-E, BB4NHD-PG, BB4NHD-PG-E, and BB4N-PSG-E)
 - NEMA Type 1, IP40 (BB4N-F and BB4NHD-F)

References

- Armitage, R. (2002). To CCTV or not to CCTV? A review of current research into the effectiveness of CCTV systems in reducing crime. NACRO Crime and Social Policy Newsletter, May.
- Barr, R., & Pease, K. (1992). A place for every crime and every crime in its place: An alternative perspective on crime displacement. In D. J. Evans, N. R. Fyfe, & D. T. Herbert (Eds.), *Crime, policing and place, essays in environmental criminology* (pp. 196-216). London: Routledge.
- Barton, M. S., Jensen, B. L., & Kaufman, J. M. (2010). Social disorganization theory and the college campus. *Journal of Criminal Justice*, 38(3), 245-254.
- Bennett, T. (1989). Burglars' choice of targets. In D. Evans & D. Herbert (Eds.), *The Geography of Crime* (pp. 176-192). New York: Routledge.
- Bennett, T., & Wright, R. (1984). *Burglars on burglary: Prevention and the offender*. Aldershot: Gower.
- Brantingham, P. J. (1981). *Environmental criminology*. Prospect Heights: Waveland Press.
- Brown, B. (1995). CCTV in town centres: Three case studies, police research group crime detection and prevention. Series paper 68, HMSO, London.
- Budd, T. (1999). *Burglary of domestic dwellings: Findings from the British crime survey*. London: Home Office.

- Campbell, K., & Bryceland, C. (1998). *Policing the campus: providing a safe and secure environment*. London: Police Research Group.
- Carter, S. P. (2002). Community CPTED. *The Journal of the International Crime Prevention Through Environmental Design Association*, 1, 15-24.
- Clarke, R. V. (1995). Situational crime prevention. In M. Tonry & D. Farrington (Eds.), *Building a safer society: Strategic approaches to crime prevention* (pp.91-150). Chicago: The University of Chicago Press.
- Clarke, R. V., & Eck, J. (2003). *Become a problem solving crime analyst in 55 small steps* (1st ed.). London: Jill Dando Institute of Crime Science - University College London.
- Clarke, R. V., & Elliot, D. (1989). Motorcycle theft, helmet legislation and displacement. *The Howard Journal of Criminal Justice*, 28, 1-8.
- Clarke, R. V., & Weisburd, D. (1994). Diffusion of crime control benefits: Observations on the reverse displacement. In R. V. Clarke (Ed.), *Crime prevention studies* (pp. 165-183). Monsey, NY: Criminal Justice Press.
- Cohen, L. E., & Felson, M. (1979). Social change and crime rate trends: A routine activity approach. *American Sociological Review*, 44(4), 588-608.
- College Board. *Factors in College Choice* [Fact sheet]. (2008). Retrieved on February 25, 2009, from <http://professionals.collegeboard.com/data-reports-research/trends/studentpoll/millennial/college-choice>

- Conklin, J. (1975). *The impact of crime*. New York: Macmillan.
- Covington, J., & Taylor, R. B. (1991). Fear of crime in urban residential neighborhoods: Implications of between and within neighborhood sources for current models. *The Sociological Quarterly*, 32, 231-49.
- Cozens, M. P., Saville, G., & Hiller, D. (2005). Crime prevention through environmental design (CPTED): A review and modern bibliography. *Property Management*, 23(5), 328-358.
- Crime Factors. (1998). *City of Cambridge Annual Crime Report* [Data file]. Retrieved from <http://www2.cambridgema.gov/cpd/reports/1998/factors.html>
- Crowe, T. D. (2000). *Crime prevention through environmental design: Applications of architectural design and space management concepts* (2nd ed.). Woburn, MA: Butterworth-Heinemann.
- Del Carmen, A., Polk, O. E., Segal, C., & Bing, R. L., III. (2000). Fear of crime on campus: Examining fear variables of CRCJ majors and nonmajors in pre- and post-serious crime environments. *Journal of Security Administration*, 23(1), 21-36.
- Department of Justice – Federal Bureau of Investigation. (2006). *Crime in the United States*. Retrieved on November 20, 2008, from http://www.fbi.gov/ucr/05cius/offenses/property_crime/index.html
- DuBow, F., McCabe, E., & Kaplan, G. (1979). *Reactions to crime: A critical view of the literature*. Chicago, Il: Northwestern University.

- Eck, J. (1997). Preventing crime at places: Why places are important. In L. W. Sherman, D. C. Gottfredson, D. C. Mackenzie, J. Eck, P. Reuter, & S. D. Bushway (Eds.), *Preventing crime: What works, what Doesn't, What's promising*. US Department of Justice. Washington, DC: National Institute of Justice Research in Brief.
- Farrington, D. P., Gill, M., Waples, S. J., & Argomaniz, J. (2007). The effects of closed circuit television on crime: Meta-analysis of an English national quasi-experimental multi-site evaluation. *Journal of Experimental Criminology*, 3(1), 21-38.
- Farrington, D. P., & Welsh, B. C. (2002). Effects of improved street lighting on crime: A systematic review. *Home Office Research Study*, 251, 1-60. London: Crown Copyright.
- Fisher, B. (1993). What works: Block watch meetings or crime prevention seminars? *Journal of Crime and Justice*, 16(1), 1-27.
- Fisher, B. S., Sloan, J. J., Cullen, F. T., & Lu, C. (1998). Crime in the ivory tower: The level and sources of student victimization. *Criminology*, 36, 671-710.
- Gabor, T. (1990). Crime displacement and situational prevention: Toward the development of some principles. *Canadian Journal of Criminology*, 32, 41-73.
- Gabriel, U., & Greve, W. (2003). The psychology of crime. *The British Journal of Criminology*, 43(3), 600.
- Gamman, L., & Pascoe, T. (2004). Design out crime? Using practice-based models of the design process. *Crime Prevention and Community Safety: An International Journal*, 6(4), 9-18.

Garofalo, J. (1977). *Public opinion about crime: The attitudes of victims and non-victims in selected cities*. National Criminal Justice Information and Statistics Service, Law Enforcement Assistance Administration, U.S. Department of Justice. Washington, D.C.: GPO.

Garofalo, J. (1981). The fear of crime: Causes and consequences. *The Journal of Criminal Law & Criminology*, 72(2), 839-857.

Gill, M., & Loveday, K. (2003). What do offenders think about CCTV? *Crime Prevention and Community Safety*, 5(3), 17-25.

Gill, M., Bryan, J., & Allen, J. (2007). Public perceptions of CCTV in residential areas: 'It is not as good as we thought it would be.' *International Criminal Justice Review*, 17(4), 304-325.

Gladstone, F. (1980). Coordinating crime prevention efforts. In D. Herbert, D. Evans & N. Fyfe (Eds.), *The distribution of crime* (62nd ed.). London: HMSO.

Goon, K. (2008, November 10). Crime numbers beat average. *Diamondback*. Retrieved from <<http://media.www.diamondbackonline.com/media/storage/paper873/news/2008/11/10/News/Crime.Numbers.Beat.Average-3534335.shtml>>

Grabosky, P. N. (1995). Fear of crime and fear reduction strategies. *Current Issues in Criminal Justice*, 7(7), 7-19.

- Guerrette, R. T., & Bowers, K. J. (2009). Assessing the extent of crime displacement and diffusion of benefits: A review of situational crime prevention evaluations. *Criminology*, 47(4), 1331-1368.
- Huang, K., Lan, C., & Kuo, M. (2005). Detecting untruthful answering in randomized response sampling. *Quality and Quantity*, 39(5), 659-669.
- Hummer, D. (2004) Serious criminality at U.S. colleges and universities: An application of the situational perspective. *Criminal Justice Policy Review*, 15(4), 391-417.
- Jennings, W. G., Gover, A. R., & Pudrynska, D. (2007). Are institutions of higher learning safe? A descriptive study of campus safety issues and self-reported campus victimization among male and female college students. *Journal of Criminal Justice Education*, 18(2), 191-208.
- Kelling, G. L., & Coles, C. M. (1996). *Fixing broken windows, restoring order and reducing crime in our communities*. New York: Touchstone, Simon and Schuster.
- Kornhauser, R. (1978). *Social Sources of Delinquency*. Chicago: University of Chicago Press.
- Laufer, W. S., Adler, F., & Mueller, G. O. W. (1999). *The criminology of criminal law: Advances in criminological theory*. Chicago: Transaction Publishers.
- Lewin, K. (1947). Frontiers in group dynamics: Channels of group life; social planning and action research. In T. M. Newcomb, & E. L. Hartley (Eds.), *Human Relations* (pp. 143-53). New York: Atherton Press.

- Lewis, D. A., & Salem, G. (1986). *Fear of crime: Incivility and the production of a social problem*. New Brunswick, NJ: Transaction Publishers.
- Liska, A. E., Lawrence, J. J., & Sanchirico, A. (1982). Fear of crime as a social fact. *Social Forces*, 60(3), 760-770.
- Local Explorer* [Database]. (2006). Retrieved on February 25, 2009, from http://www.washingtonpost.com/wp-srv/local-explorer/?nid=roll_locaexplorer
- Madensen, T. D., Tillyer, M. S., & Wilcox, P. (2007). Guardianship in context: Implications for burglary victimization risk and prevention. *Criminology*, 45(4), 771.
- Maxfield, M. G. (1984). *Fear of Crime in England and Wales*. London: H.M. Stationary Office.
- McConnell, E. H. (1997). Fear of crime on campus: A study of a southern university. *Journal of Security Administration*, 20(2), 22.
- Ministry of Justice, New Zealand. (2005). National guidelines for Crime Prevention through Environmental Design in New Zealand part 2: Implementation guide. Retrieved from <http://www.justice.govt.nz/publications/global-publications/n/national-guidelines-for-crime-prevention-through-environmental-design-in-new-zealand-part-2-implementation-guide>
- Moore, M. H., & Trojanowicz, R. C. (1988). Policing and the fear of crime. *Perspectives on Policing*, 3, 1-7. Washington D.C.: U.S. Department of Justice.
- Office of Institutional Research, Planning & Assessment. (2010). University of Maryland.
- Pawson, R., & Tilley, N. (1997). *Realistic evaluation*. London: Sage Publications.

- Pease, K. (1991). The Kirkholt project: Preventing burglary on a British public housing estate. *Security Journal*, 2, 73-77.
- Perkins, D. D., Florin, P., Rich, R. C., Wandersman, A., & Chavis, D. M. (1990). Participation and the social and physical environment of residential blocks: Crime and community context. *American Journal of Community Psychology*, 17, 83-115.
- Poyner, B. (1992). Video cameras and bus vandalism. In R. V. Clarke (Ed.), *Situational crime prevention: Successful case studies* (1st ed.). New York, N.Y.: Harrow and Heston.
- Ratcliffe, J. (2003). Suburb boundaries and residential burglars. *Trends and Issues in Crime and Criminal Justice*, 246, 1-6.
- Rathus, S. A. (2004). *Psychology: Concepts and connections* (9th ed.). New York: Thomson Wadsworth.
- Reed, J., & Ainsworth, B. (2007). Perceptions of environmental supports on the physical activity behaviors of university men and women: A preliminary investigation. *Journal of American College Health*, 56(2), 199-204.
- Reynald, D. (2010). Guardians on guardianship: Factors affecting the willingness to supervise, the ability to detect potential offenders, and the willingness to intervene. *Journal of Research in Crime and Delinquency*, 47(3), 358-390.
- Riegel, L. (2002). Crime prevention through environmental design in parking. *Campus Law Enforcement Journal*, (January/February), 28-29.

- Rondeaux, C. (2007, October 21). Homicides increase: Other violent crimes down. *The Washington Post*. Retrieved from <http://pqasb.pqarchiver.com/washingtonpost/access/1374801151.html?FMT=ABS&FMTS=ABS:FT&date=Oct+31%2C+2007&author=Candace+Rondeaux+-+Washington+Post+Staff+Writer&desc=Homicides+Increase%3B+Other+Violent+Crimes+Down>.
- Sakissan, W., Perglut, D., Ballard, E., & Walsh, K. (1994). *Community participation in practice: The community participation handbook* (2nd ed.). Sydney: Murdoch University.
- Sampson, R. J., & Groves, W. B. (1989). Community structure and crime: Testing social-disorganization theory. *The American Journal of Sociology*, 94(4), 774-802.
- Sasse, S. (2005). "Motivation" and routine activities theory. *Deviant Behavior*, 26(6), 547.
- Saville, G. (1995). *Crime problems, community solutions: Environmental criminology as a developing prevention strategy*. Vancouver: AAG Publishing.
- Saville, G., & Cleveland, G. (2003). An introduction to 2nd generation CPTED: Part 2. *CPTED Perspectives*, 6(1), 7-9.
- Schweitzer, J. H., Kim, J. W., & Mackin, J. R. (1999). The impact of the built environment on crime and fear of crime in urban neighborhoods. *Journal of Urban Technology*, 6(3), 59.
- Sherman, L. W., Gartin, P. R., & Buerger, M. E. (1989). Hot spots of predatory crime: Routine activities and the criminology of place. *Criminology*, 27(1), 27-55.

- Smith, P., Spriggs, A., Argomaniz, J., Allen, J., Follett, M., Jessiman, P., Kara, D., ... Gill, M. (2003). Lessons in implementing CCTV schemes: An early review. In M. Gill (Ed.), *CCTV*. Leicester: Perpetuity Press.
- Sorenson, D. (2003). The nature and prevention of residential burglary: A review of the international literature with an eye towards prevention in Denmark. Retrieved from www.jur.ku.dk/medarbejdere/davesorensen/Publikationer/Nature.pdf on November 27, 2008.
- Stephens, R., Rau Vargas, M., & Kruger, T. (2004). Public participation in developing countries. The Council for Scientific and Industrial Research, South Africa. Retrieved from <http://www.buildnet.co.za/akani/2004/nov/pdfs/thirdworldcountries.pdf>
- Taylor, R. B. (1988) *Human Territorial Functioning: An Empirical Evolutionary Perspective on Individual and Small Group Territorial Cognitions, Behaviors, and Consequences*. New York: Cambridge University Press.
- Taylor, R. B., & Hale, M. (1986). Testing alternative models of fear of crime. *Journal of Criminal Law and Criminology*, 77(1), 151-189.
- Town, S. (2002). *Crime displacement, the perception, problems, evidence and supporting theory*. Retrieved from www.crimereduction.gov.au/skills10.htm on November 27, 2008.
- Tseloni, A., Wittebrood, K., Farrell, G., & Pease, K. (2004). Burglary victimization in England and Wales, the United States and the Netherlands: A cross-national comparative test of routine activities and lifestyle theories. *The British Journal of Criminology*, 44(1), 66-91.

Tseng, N. C., Duane, N. J., & Hadipriono, N. F. (2004). Performance of campus parking garages in preventing crime. *Journal of Performance of Constructed Facilities*, 18(1), 21-28.

US Department of Education. (n.d.). Institution data: University of Maryland College Park.

Retrieved from

<http://ope.ed.gov/security/InstDetails.aspx?706172656e7469643d31363332383626756e697469643d31363332383630303126796561723d32303039267264743d342f31332f3230313120333a34343a353820504d>

Waples, S., Gill, M., & Fisher, P. (2009). Does CCTV displace crime? *Criminology & Criminal Justice: An International Journal*, 9(2), 207-224. doi:10.1177/1748895809102554

Weisel, D. (2002). *Burglary of single-family houses*. Washington, DC: Office of Community Oriented Policing Services, Department of Justice.

Welsh, B., & Farrington, D. (2004). Surveillance for crime prevention in public space: Results and policy choices in Britain and America. *Criminology & Public Policy*, 3(3), 497-525. Retrieved August 28, 2009, from Academic Search Premier database.

Welsh, B. C., & Farrington, D. P. (2007). *Improved street lighting and crime prevention*. Stockholm: Swedish Council for Crime Prevention, Information and Publications.

Welsh, B. C., & Farrington, D. P. (2009). Public area CCTV and crime prevention: An updated systematic review and meta-analysis. *Justice Quarterly*, 26(4), 716-745.

Wilcox, P., Jordan, C. E., & Pritchard, A. J. (2007). A multidimensional examination of campus safety: Victimization, perceptions of danger, worry about crime, and precautionary

behavior among college women in the post-Clery era. *Crime & Delinquency*, 53(2), 219-254.

Williams, D. (2007). Effective CCTV and the challenge of constructing legitimate suspicion using remote visual images. *Journal of Investigative Psychology & Offender Profiling*, 4(2), 97-107. Retrieved August 28, 2009, doi:10.1002/jip.68

Wilson, D., & Sutton, A. (2003). Open-street CCTV in Australia. *Australian Institute of Criminology Trends and Issues in Crime and Criminal Justice*, (271). Australian Institute of Criminology, Canberra.